

**Compendium of Methods
for the Determination of
Toxic Organic Compounds
in Ambient Air**

Second Edition

Compendium Method TO-11A

**Determination of Formaldehyde in Ambient Air
Using Adsorbent Cartridge Followed by High
Performance Liquid Chromatography (HPLC)
[Active Sampling Methodology]**

**Center for Environmental Research Information
Office of Research and Development
U.S. Environmental Protection Agency
Cincinnati, OH 45268**

January 1999

Method TO-11A Acknowledgements

This Method was prepared for publication in the *Compendium of Methods for the Determination of Toxic Organic Compounds in Ambient Air, Second Edition* (EPA/625/R-96/010b), which was prepared under Contract No. 68-C3-0315, WA No. 3-10, by Midwest Research Institute (MRI), as a subcontractor to Eastern Research Group, Inc. (ERG), and under the sponsorship of the U.S. Environmental Protection Agency (EPA). Justice A. Manning, John O. Burckle, and Scott Hedges, Center for Environmental Research Information (CERI), and Frank F. McElroy, National Exposure Research Laboratory (NERL), all in the EPA Office of Research and Development, were responsible for overseeing the preparation of this method. Additional support was provided by other members of the Compendia Workgroup, which include:

- John O. Burckle, U.S. EPA, ORD, Cincinnati, OH
- James L. Cheney, Corps of Engineers, Omaha, NB
- Michael Davis, U.S. EPA, Region 7, KC, KS
- Joseph B. Elkins Jr., U.S. EPA, OAQPS, RTP, NC
- Robert G. Lewis, U.S. EPA, NERL, RTP, NC
- Justice A. Manning, U.S. EPA, ORD, Cincinnati, OH
- William A. McClenny, U.S. EPA, NERL, RTP, NC
- Frank F. McElroy, U.S. EPA, NERL, RTP, NC
- Heidi Schultz, ERG, Lexington, MA
- William T. "Jerry" Winberry, Jr., EnviroTech Solutions, Cary, NC

Method TO-11 was originally published in March of 1989 as one of a series of peer reviewed methods in the second supplement to "*Compendium of Methods for the Determination of Toxic Organic Compounds in Ambient Air*," EPA 600/4-89-018. In an effort to keep these methods consistent with current technology, Method TO-11 has been revised and updated as Method TO-11A in this Compendium to incorporate new or improved sampling and analytical technologies.

This Method is the result of the efforts of many individuals. Gratitude goes to each person involved in the preparation and review of this methodology.

Author(s)

- William T. "Jerry" Winberry, Jr., EnviroTech Solutions, Cary, NC
- Silvestre Tejada, U.S. EPA, NERL, RTP, NC
- Bill Lonneman, U.S. EPA, NERL, RTP, NC
- Ted Kleindienst, ManTech, RTP, NC

Peer Reviewers

- Robert G. Lewis, U.S. EPA, NERL, RTP, NC
- Sucha S. Parmar, Atmospheric Analysis and Consulting, Ventura, CA
- Joette Steger, Eastern Research Group, Morrisville, NC
- Lauren Drees, U.S. EPA, NRMRL, Cincinnati, OH

Finally, recognition is given to Frances Beyer, Lynn Kaufman, Debbie Bond, Cathy Whitaker, and Kathy Johnson of Midwest Research Institute's Administrative Services staff whose dedication and persistence during the development of this manuscript has enabled its publication.

DISCLAIMER

This Compendium has been subjected to the Agency's peer and administrative review, and it has been approved for publication as an EPA document. Mention of trade names or commercial products does not constitute endorsement or recommendation for use.

Method TO-11A

Determination of Formaldehyde in Ambient Air Using Adsorbent Cartridge Followed by High Performance Liquid Chromatography (HPLC) [Active Sampling Methodology]

TABLE OF CONTENTS

	<u>Page</u>
1. Scope	11A-1
2. Applicable Documents	11A-3
2.1 ASTM Standards	11A-3
2.2 Other Documents	11A-3
2.3 Other Documents	11A-3
3. Summary of Method	11A-3
4. Significance	11A-4
5. Definitions	11A-6
5.1 C18	11A-6
5.2 HPLC	11A-6
5.3 Method Detection Limit (MDL)	11A-6
5.4 Photochemical Reaction	11A-6
5.5 Photochemical Smog	11A-6
5.6 ppbv	11A-6
5.7 ppmv	11A-6
5.8 Silica Gel	11A-6
5.9 Denuder	11A-7
5.10 Certification Blank	11A-7
5.11 Cartridge Blank	11A-7
5.12 Scrubber	11A-7
6. Extended Methodology and Common Interferences	11A-7
7. Apparatus	11A-8
7.1 Isocratic HPLC	11A-8
7.2 Cartridge sampler.	11A-8
7.3 Sampling system	11A-9
7.4 Stopwatch.	11A-10
7.5 Polypropylene shipping container with polyethylene-air bubble padding.	11A-10
7.6 Thermometer	11A-10
7.7 Barometer (optional).	11A-10
7.8 Volumetric flasks.	11A-11
7.9 Pipets.	11A-11
7.10 Erlenmeyer flask, 1 L.	11A-11
7.11 Graduated cylinder, 1 L.	11A-11
7.12 Syringe, 100-250 μ L.	11A-11
7.13 Sample vials.	11A-11

TABLE OF CONTENTS (continued)

	<u>Page</u>
7.14 Melting point apparatus	11A-11
7.15 Rotameters	11A-11
7.16 Calibrated syringes	11A-11
7.17 Soap bubble meter or wet test meter	11A-11
7.18 Mass flow meters and mass flow controllers	11A-11
7.19 Positive displacement	11A-11
7.20 Cartridge drying manifold	11A-11
7.21 Liquid syringes	11A-11
7.22 Syringe rack	11A-11
7.23 Luer® fittings/plugs.	11A-11
7.24 Hot plates, beakers, flasks, measuring and disposable pipets, volumetric flasks, etc.	11A-11
7.25 Culture tubes (20 mm x 125 mm) with polypropylene screw caps	11A-11
7.26 Polyethylene gloves.	11A-11
7.27 Dry test meter.	11A-12
7.28 User-prepared copper tubing for ozone scrubber	11A-12
7.29 Cord heater and Variac.	11A-12
7.30 Fittings.	11A-12
8. Reagents and Materials	11A-12
8.1 2,4-Dinitrophenylhydrazine (DNPH)	11A-12
8.2 DNPH coated cartridges	11A-12
8.3 High purity acetonitrile.	11A-12
8.4 Deionized-distilled water.	11A-12
8.5 Perchloric acid.	11A-12
8.6 Ortho-phosphoric acid.	11A-12
8.7 Formaldehyde.	11A-12
8.8 Aldehydes and ketones, analytical grade, best source.	11A-12
8.9 Carbonyl hydrazone	11A-12
8.10 Ethanol or methanol	11A-13
8.11 Nitrogen	11A-13
8.12 Charcoal	11A-13
8.13 Helium	11A-13
8.14 Potassium Iodide	11A-13
9. Preparation of Reagents and Cartridges	11A-13
9.1 Purity of the Acetonitrile	11A-13
9.2 Purification of 2,4-Dinitrophenylhydrazine (DNPH)	11A-14
9.3 Preparation of DNPH-Formaldehyde Derivative	11A-15
9.4 Preparation of DNPH-Formaldehyde Standards	11A-15
9.5 Preparation of DNPH-Coated Cartridges	11A-15
9.6 Equivalent Formaldehyde Cartridge Concentration	11A-18
10. Sampling Procedure	11A-18

TABLE OF CONTENTS (continued)

	<u>Page</u>
11. Sample Analysis	11A-21
11.1 Sample Preparation	11A-21
11.2 Sample Extraction	11A-21
11.3 HPLC Analysis	11A-22
11.4 HPLC Calibration	11A-23
12. Calculations	11A-24
13. Performance Criteria and Quality Assurance	11A-27
13.1 Standard Operating Procedures (SOPs)	11A-27
13.2 HPLC System Performance	11A-27
13.3 Process Blanks	11A-28
13.4 Method Precision and Accuracy	11A-28
13.5 Method Detection Limits	11A-28
13.6 General QA/QC Requirements	11A-29
14. Detection of Other Aldehydes and Ketones	11A-29
14.1 Introduction	11A-30
14.2 Sampling Procedures	11A-30
14.3 HPLC Analysis	11A-30
15. Precision and Bias	11A-31
16. References	11A-32

METHOD TO-11A

Determination of Formaldehyde in Ambient Air Using Adsorbent Cartridge Followed by High Performance Liquid Chromatography (HPLC) [Active Sampling Methodology]

1. Scope

1.1 This document describes a method for the determination of formaldehyde and other carbonyl compounds (aldehydes and ketones) in ambient air utilizing a coated-solid adsorbent followed by high performance liquid chromatographic detection. Formaldehyde has been found to be a major promoter in the formation of photochemical ozone. In particular, short term exposure to formaldehyde and other specific aldehydes (acetaldehyde, acrolein, crotonaldehyde) is known to cause irritation of the eyes, skin, and mucous membranes of the upper respiratory tract.

1.2 Over the last several years, numerous methods have been developed for the sampling and analysis of carbonyl compounds. Because of the role which formaldehyde plays in photochemistry, most of the more recent methods were designed to quantitate formaldehyde specifically. Early methods centered around wet chemical technology involving a bubbler or impinger containing a reactive reagent (1). In some cases the reactive reagent produced a color in the presence of formaldehyde. Examples of the more commonly used reagents were: 3-methyl-2-benzothiazolone hydrazone (MBTH), sodium sulfite, 4-hexylresorcinol, water, sodium tetrachloromercurate, and chromatropic acid. These reagents demonstrated high collection efficiency (>95%), provided fairly stable non-volatile products and minimized formation of undesirable by-products. Indeed, as part of U. S. Environmental Protection Agency's (EPA's) effort to quantitate atmospheric concentrations of formaldehyde, the National Air Sampling Network utilized the impinger technique for several years containing chromatropic acid specifically for formaldehyde. However, impinger sampling had numerous weaknesses which eventually lead to its demise. They were:

- Labor intense.
- Used acidic/hazardous reagents.
- Lacked sensitivity.
- Prone to interferences.
- Poor reproducibility at ambient concentration levels.

As EPA's interest focused upon formaldehyde and its sources, the development of passive personal sampling devices (PSDs) developed (2). These devices were mainly used by industrial hygienists to assess the efforts of respiratory exposure for formaldehyde on workers. However, because of the design and flow rate limitation, they require long exposures (up to 7 days) to the atmosphere to meet traditional bubbler technique sensitivities. Consequently, the passive PSD had limited application to ambient monitoring.

To address the need for a monitoring method to sample carbonyl compounds in the air at sensitivities needed to reach health-base detection limits (10^{-6} risk level), a combination of wet chemistry and solid adsorbent methodology was developed (3-6). Activating or wetting the surface of an adsorbent with a chemical specific for reacting with carbonyl compounds allowed greater volumes of air to be sampled, thus enabling better sensitivity in the methodology. Various chemicals and adsorbents combinations have been utilized with various levels of success. The most commonly used technique is based on reacting airborne carbonyls with 2,4-dinitrophenylhydrazine (2,4-DNPH) coated on an adsorbent cartridge followed by separation and analysis of the hydrazone derivative by high performance liquid chromatography (HPLC) with ultraviolet (UV) detection.

1.3 Historically, Compendium Method TO-5, "*Method For the Determination of Aldehydes and Ketones in Ambient Air Using High Performance Liquid Chromatography (HPLC)*" was used to quantitate formaldehyde in ambient air. This method involved drawing ambient air through a midjet impinger sampling train containing 10 mL of 2N HCl/0.05% 2,4-DNPH reagent. Formaldehyde (and other aldehydes and ketones) readily formed a stable derivative with the DNPH reagent, and the DNPH derivative is analyzed for aldehydes and ketones utilizing HPLC. Compendium Method TO-11 modifies the

sampling procedures outlined in Method TO-5 by introducing a coated adsorbent. Compendium Method TO-11 is based on the specific reaction of organic carbonyl compounds (aldehydes and ketones) with DNPH-coated silica gel cartridges in the presence of a strong acid, as a catalyst, to form a stable color hydrazone derivative according to the following reaction:

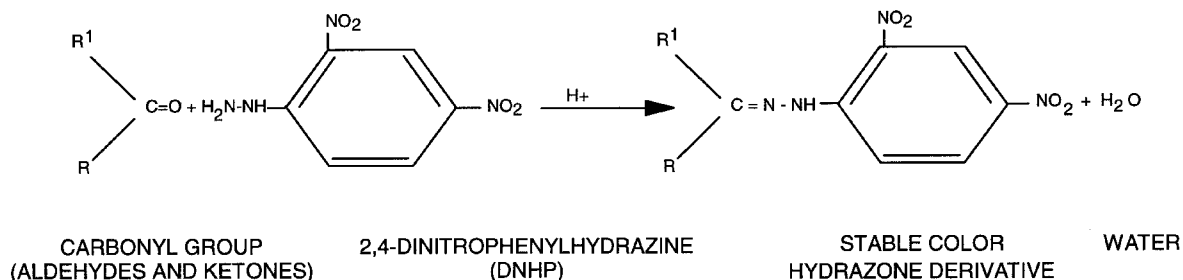

where R and R¹ are organic alkyl or aromatic group (ketones) or either substituent is a hydrogen (aldehydes). The reaction proceeds by nucleophilic addition to the carbonyl followed by 1,2-elimination of water to form the 2,4-dinitrophenylhydrazone derivative. The determination of formaldehyde from the DNPH-formaldehyde derivative is similar to Method TO-5 in incorporating HPLC as the analytical methodology.

1.4 Due to recent requirements in atmospheric carbonyl monitoring, EPA has determined a need to update the present methodology found in Compendium Method TO-11. The revised Compendium Method TO-11A, as published here, includes:

- Guidance on collocated sampling.
- Addition of ozone denuder or scrubber to reduce interferences.
- Sampler design update to allow heated-inlet and sequential sampling.
- Update HPLC procedure for column alternatives.
- Use of commercially prepared low pressure drop DNPH-coated cartridges.

The target compound for this method is formaldehyde; however, at least 14 other carbonyl compounds can be detected and quantified.

1.5 The sampling method gives a time-weighted average (TWA) sample. It can be used for long-term (1-24 hr) sampling of ambient air where the concentration of formaldehyde is generally in the low ppb (v/v) or for short-term (5-60 min) sampling of source-impacted atmospheres where the concentration of formaldehyde could reach the ppm (v/v) levels.

1.6 The method instructs the user to purchase commercially pre-coated DNPH cartridges. The method still includes the instructions of Compendium Method TO-11 for the preparation of DNPH-coated cartridges. However due to the tedious preparation and clean room requirements, the method recommends the purchase of pre-coated DNPH cartridges that are now commercially available from at least three major suppliers. Different from previous cartridges identified in Compendium Method TO-11, the pressure drop across the newer low-pressure drop cartridges are less than 37 inches of water at a sampling flow of up to 2.0 liters/minute, allowing compatibility with pumps used in personal sampling equipment. These pre-coated commercial cartridges have generally lower and more consistent background (7) concentration of carbonyls than cartridges prepared under normal chemical laboratory environment, as specified in the original Compendium Method TO-11.

1.7 The commercially-prepared pre-coated cartridges are used as received and are discarded after use. The collected and uncollected cartridges are stored in culture tubes with polypropylene caps and placed in cold storage when not in use.

1.8 This method may involve hazardous materials, operations, and equipments. This method does not purport to address all the safety problems associated with its use. It is the responsibility of whoever uses this method to consult and establish appropriate safety and health practices and determine the applicability of regulatory limitations prior to use.

2. Applicable Documents

2.1 ASTM Standards

- D1193 *Specification for Reagent Water*
- D1356 *Terminology Relating to Atmospheric Sampling and Analysis*
- D3195 *Practice for Rotameter Calibration*
- D3631 *Method for Measuring Surface Atmospheric Pressure*
- D5197 *Determination of Formaldehyde and Other Carbonyl Compounds in Air (Active Sampler Methodology)*
- E177 *Practice for Use of the Terms Precision and Bias in ASTM Test Methods*
- E682 *Practice for Liquid Chromatography Terms and Relationships*

2.2 Other Documents

- *Technical Assistance Document for Sampling and Analysis Toxic Organic Compounds in Ambient Air*, U. S. Environmental Protection Agency, EPA-600/4-83-027, June 1983.
- *Quality Assurance Handbook for Air Pollution Measurement Systems*, U. S. Environmental Protection Agency, EPA-600/R-94-D38b, May 1994.
- *Compendium of Methods for the Determination of Toxic Organic Compounds in Ambient Air: Method TO-11, Second Supplement*, U. S. Environmental Protection Agency, EPA-600/4-89-018, March 1989.

2.3 Other Documents

- Existing Procedures (8-10).
- Ambient Air Studies (11-15).

3. Summary of Method

3.1 A known volume of ambient air is drawn through a prepacked cartridge coated with acidified DNPH at a sampling rate of 100-2000 mL/min for an appropriate period of time. Sampling rate and time are dependent upon carbonyl concentration in the test atmosphere.

3.2 After sampling, the sample cartridges and field blanks are individually capped and placed in shipping tubes with polypropylene caps. Sample identifying tags and labels are then attached to the capped tubes. The capped tubes are then placed in a polypropylene shipping container cooled to subambient temperature ($\sim 4^{\circ}\text{C}$), and returned to the laboratory for analysis. Alternatively, the sample vials can be placed in a thermally-insulated styrofoam box with appropriate padding for shipment to the laboratory. The cartridges may either be placed in cold storage until analysis or immediately washed by gravity feed elution with 5 mL of acetonitrile from a plastic syringe reservoir to a graduated test tube or a 5 mL volumetric flask.

3.3 The eluate is then diluted to a known volume and refrigerated until analysis.

3.4 For determining formaldehyde, the DNPH-formaldehyde derivative can be determined using isocratic reverse phase HPLC with an ultraviolet (UV) absorption detector operated at 360 nm. To determine formaldehyde and 14 other carbonyls, the HPLC system is operated in the linear gradient program mode.

3.5 For quantitative evaluation of formaldehyde and other carbonyl compounds, a cartridge blank is likewise desorbed and analyzed.

3.6 Formaldehyde and other carbonyl compounds in the sample are identified and quantified by comparison of their retention times and peak heights or peak areas with those of standard solutions. Typically, C₁-C₇ carbonyl compounds, including benzaldehyde, are measured effectively to less than 0.5 ppbv.

4. Significance

4.1 Formaldehyde is a major compound in the formation of photochemical ozone (16). Short term exposure to formaldehyde and other specific aldehydes (acetaldehyde, acrolein, crotonaldehyde) is known to cause irritation of the eyes, skin, and mucous membranes of the upper respiratory tract (19). Animal studies indicate that high concentrations can injure the lungs and other organs of the body (19). In polluted atmospheres, formaldehyde may contribute to eye irritation and unpleasant odors that are common annoyances.

4.2 Over the last several years, carbonyl compounds including low molecular weight aldehydes and ketones have received increased attention in the regulatory community. This is due in part to their effects on humans and animals as primary irritation of the mucous membranes of the eyes, the upper respiratory tract, and the skin. Animal studies indicate that high concentrations of carbonyl compounds, especially formaldehyde, can injure the lungs, may contribute to eye irritation and effect other organs of the body. Aldehydes, either directly or indirectly, may also cause injury to plants. Sources of carbonyl compounds into the atmosphere range from natural occurrences to secondary formation through atmospheric photochemical reactions. Consequently, carbonyl compounds are both primary (directly emitted) and secondary (formed in the atmosphere) air pollutants (19).

4.2.1 Natural Occurrence. Natural sources of carbonyls do not appear to be important contributors to air pollution. Acetaldehyde is found in apples and as a by-product of alcoholic fermentation process. Other lower molecular weight aliphatic aldehydes are not found in significant quantities in natural products. Olefinic and aromatic aldehydes are present in some of the essential oils in fruits and plants. These include citronella, in rose oil; citral, in oil of lemongrass; benzaldehyde, in oil of bitter almonds; and cinnamaldehyde, in oil of cinnamon.

4.2.2 Production Sources. Aldehydes are commercially manufactured by various processes, depending on the particular aldehyde. In general, they are prepared via oxidation reactions of hydrocarbons, hydroformulation of alkenes, dehydrogenation of alcohols, and addition reactions between aldehydes and other compounds. Formaldehyde is manufactured from the oxidation of methanol as illustrated in the following equation:

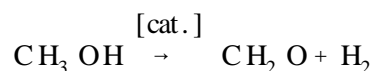

Formaldehyde and other aldehyde production in the United States has shown a substantial growth over the last several years. This is due, in part, to their use in a wide variety of industries, such as the chemical, rubber, tanning, paper, perfume, and food industries. The major use is as an intermediate in the synthesis of organic compounds, including, alcohols, carboxylic acids, dyes, and medicinals.

4.2.3 Mobile Combustion Sources. A major source of carbonyl compounds in the atmosphere may be attributed to motor vehicle emissions. In particular, formaldehyde is the major carbonyl in automobile exhaust, accounting for 50-70 percent of the total carbonyl burden to the atmosphere (19). Furthermore, motor vehicles emit reactive hydrocarbons that undergo photochemical oxidation to produce formaldehyde and other carbonyls in the atmosphere.

4.3 Secondary Pollutant. As a secondary pollutant (formed in the atmosphere), carbonyls are formed by very complex photo-oxidation mechanism involving volatile organic compounds (VOCs) with nitrogen oxide (20,21). Both anthropogenic and biogenic (e.g., isoprene) hydrocarbons leads to *in situ* formation of carbonyls, especially formaldehyde compounds. Aldehydes are both primary pollutants and secondary products of atmospheric photochemistry.

The complete photo-oxidation mechanism is indeed complex and not well understood. However, a brief discussion is warranted (22). When VOCs and oxides of nitrogen (NO_x) are in the atmosphere and are irradiated with sunlight, their equilibrium in the photostationary state is changed. The photostationary state is defined by the equilibrium between nitrogen dioxide (NO_2), nitrous oxide (NO) and ozone (O_3). This equilibrium is theoretically maintained until VOCs are introduced. Various reactions occur to produce OH radicals. The VOCs react with the OH radicals and produce RO_2 radicals that oxidizes NO to NO_2 , destroying the photostationary state. Carbonyls react with OH to produce RO_2 radicals. Likewise carbonyls, particularly formaldehyde in sunlight, are sources of the OH radicals.

The results of these processes lead to the following:

- Accumulation of ozone.
- Oxidation of hydrocarbons (HCs) to aldehydes and ketones which lead to the continued production of HO_2 and OH radicals, the real driving force in photochemistry smog.

Consequently, the determination of formaldehyde and other carbonyl compounds in the atmosphere is of interest because of their importance as precursors in the production of photochemical smog, as photochemical reaction products and as major source of free radicals in the atmosphere.

4.4 Historically, DNPH impinger techniques have been widely used to determine atmospheric carbonyls. However, due to the limitation of applying this technique to remote locations, the solid adsorbent methodology has become a convenient alternative to impinger sampling. A number of solid adsorbents have been used over the years to support the DNPH coating. They are: glass beads, glass fiber filters, silica gel, Chromosorb® P, Florisil®, Carbo-pack® B, XAD-2, and C18. Several of these adsorbents are available commercially as pre-packed cartridges. The commercially available cartridges provide convenience of use, reproducibility and low formaldehyde blanks. Two of the more widely used pre-packed adsorbents are silica gel and C18.

4.4.1 Silica Gel. Silica gel is a regenerative adsorbent, consisting of amorphous silica (SiO_2) with surface OH groups, making it a polar material and enhancing surface absorption. DNPH-coated silica gel cartridges have been used by numerous investigators since 1980 for sampling formaldehyde in ambient air. Tejada (3,4) evaluated several adsorbents, including C18, Florisil, silanized glass wool, and silica gel as possible supports for the DNPH coating. Results indicated that silica gel provided the best support with minimum interferences. The studies did document that olefinic aldehydes such as acrolein and crotonaldehyde degraded partially and formed unknown species. For stable carbonyls such as formaldehyde, acetaldehyde, propionaldehyde, benzaldehyde, and acetone, correlation with an DNPH-impinger technique was excellent. However, further studies by Arnts and Tejada identified a severe loss of carbonyl-DNPH derivative due to the reaction of atmospheric ozone on DNPH-coated silica gel cartridges while sampling ambient air. This bias was eliminated when sampling continued with the application of an ozone scrubber system (KI denuder) preceding the cartridge.

4.4.2 C18 Cartridge. C18 is an octadecylsilane bonded silica substrate which is non-polar, hydrophobic, and relatively inert, whose surface has been passivated with non-polar paraffinic groups. Because of these qualities,

C18 has been used historically as an adsorbent trap for trace organics in environmental aqueous samples through hydrophobic interactions. The adsorbed trace organic molecules are then eluted from the adsorbent with various organic solvents. In early 1990, C18 was used in an ambient air study as the support for DNPH. While C18 showed promising results (23), its use today as the support for DNPH is limited.

4.5 Both adsorbents have historically performed adequately as the support for the DNPH coating. The comparison between silica gel and C18 as the adsorbent for the DNPH is illustrated in Table 1. The user is encouraged to review the weaknesses and strengths outlined in Table 1 for using silica gel or C18 as the adsorbent for the DNPH coating.

5. Definitions

[Note: Definitions used in this document and any user-prepared Standard Operating Procedures (SOPs) should be consistent with those used in ASTM D1356. All abbreviations and symbols are defined within this document at the point of first use.]

5.1 C18— C18 is an octadecylsilane bonded silica substrate, which is non-polar, hydrophobic, and relatively inert.

5.2 HPLC— high performance liquid chromatography.

5.3 Method Detection Limit (MDL)— the minimum concentration of an analyte that can be reported with 95% confidence that the value is above zero, based on a standard deviation of at least seven repetitive measurements of the analyte in the matrix of concern at a concentration near the low standard.

5.4 Photochemical Reaction— any chemical reaction that is initiated as a result of absorption of light.

5.5 Photochemical Smog— air pollution resulting from photochemical reactions.

5.6 ppbv— a unit of measure of the concentration of gases in air expressed as parts of the gas per billion (10^9) parts of the air-gas mixture, normally both by volume.

5.7 ppmv— a unit of measure of the concentration of gases in air expressed as parts of the gas per million (10^6) parts of the air-gas mixture, normally both by volume.

5.8 Silica Gel—silica gel is a regenerative adsorbent consisting of amorphous silica (SiO_2) with OH surface groups making it a polar material and enhancing surface reactions.

5.9 Denuder— A device designed to remove gases from an air sampling stream by the process of molecular diffusion to a collecting surface.

5.10 Certification Blank— certification blank is defined as the mean value of the cartridge blank plus three standard deviations. For Compendium Method TO-11A, the Certification Blank should be less than 0.15 μg /cartridge for formaldehyde.

5.11 Cartridge Blank— cartridge blank is the measured value of the carbonyl compounds on an unsampled, DNPH-coated cartridge. This is the value used in the calculations delineated in section 12.

5.12 Scrubber— to remove a specific gas from the air stream by passing through a pack bed.

6. Extended Methodology and Common Interferences

6.1 This procedure has been written specifically for the sampling and analysis of formaldehyde. Other carbonyl compounds found in ambient air are also observed in the HPLC analysis. Resolution of these compounds depend upon column and mobile phase conditions during HPLC analysis. Organic compounds that have the same retention time and significant absorbance at 360 nm as the DNPH derivative of formaldehyde will interfere. Such interferences (24) can often be overcome by altering the separation conditions (e.g., using alternative HPLC columns or mobile phase compositions). In addition, other aldehydes and ketones can be detected with a modification of the basic procedure. In particular, chromatographic conditions can be optimized to separate acetone and propionaldehyde and 12 other higher molecular weight aldehydes and ketones (within an analysis time of about one hour), as identified below, by utilizing one or two Zorbax ODS columns in series under a linear gradient program:

Formaldehyde	Isovaleraldehyde	Propionaldehyde	p-Tolualdehyde
Acetaldehyde	Valeraldehyde	Crotonaldehyde	Hexanaldehyde
o-Tolualdehyde	Butyraldehyde	2,5-Dimethylbenzaldehyde	Methyl ethyl ketone
Acetone	m-Tolualdehyde	Benzaldehyde	

The linear gradient program varies the mobile phase composition periodically to achieve maximum resolution of the C-3, C-4, and benzaldehyde region of the chromatogram.

6.2 Formaldehyde may be a contamination of the DNPH reagent. If user-prepared cartridges are employed, the DNPH must be purified by multiple recrystallizations in UV grade carbonyl-free acetonitrile. Recrystallization is accomplished at 40-60°C by slow evaporation of the solvent to maximize crystal size. The purified DNPH crystals are stored under UV grade carbonyl-free acetonitrile until use. Impurity levels of carbonyl compounds in the DNPH are determined by HPLC prior to use and should be less than the Certification Blank value of 0.15 µg/cartridge.

6.3 The purity of acetonitrile is an important consideration in the determination of allowable formaldehyde blank concentration in the reagent. Background concentrations of formaldehyde in acetonitrile will be quantitatively converted to the hydrazone, adding a positive bias to the ambient air formaldehyde concentration. Within the project quality control procedures, the formaldehyde in the acetonitrile reagent should be checked on a regular basis (see Section 9.1).

6.4 Ozone at high concentrations has been shown to interfere negatively by reacting with both the DNPH and its carbonyl derivatives (hydrazones) on the cartridge (25,26). The extent of interference depends on the temporal variations of both the ozone and the carbonyl compounds and the duration of sampling. Significant negative interference from ozone was observed even at concentrations of formaldehyde and ozone typical of clean ambient air (i.e., 2 and 40 ppb, respectively).

6.5 Exposure of the DNPH-coated sampling cartridges to direct sunlight may produce artifacts and should be avoided.

6.6 The presence of ozone in the sample stream is readily inferred from the appearance of new compounds with retention times different from the other carbonyl hydrazone compounds.

6.7 The most direct solution to the ozone interference is to remove the ozone before the sample stream reaches the coated cartridge. This process entails constructing an ozone denuder (9) or scrubber and placing it in front of the cartridge. The denuder can be constructed of 1 m of 0.64-cm outside diameter (O.D.) by 0.46-cm inside diameter (I.D.) copper tubing, that is filled with a saturated solution of KI, allowed to stand for a few minutes, drained and dried

with a stream of clean air or nitrogen for about 1 h. The capacity of the ozone denuder as described is about 100,000 ppb-hour of ozone. Packed-bed granular potassium iodide (KI) scrubbers can also be used in place of the denuder and are commercially available. Very little work has been done on long term usage of a denuder or KI scrubber to remove ozone from the ambient air gas stream. The ozone removal devices should be replaced periodically (e.g., monthly) in the sample train to maintain the integrity of the data generated.

6.8 Test aldehydes or carbonyls (formaldehyde, acetaldehyde, acrolein, propionaldehyde, benzaldehyde, and p-tolualdehyde) that were dynamically spiked into an ambient sample air stream passed through the KI denuder with practically no losses (7). Similar tests were also performed for formaldehyde (26).

6.9 Ozone scrubbers (cartridge filled with granular KI) are also available from suppliers of pre-coated DNPH cartridges. These scrubbers are optimized when the ambient air contains a minimum of 15% relative humidity.

7. Apparatus

7.1 Isocratic HPLC. System consisting of a mobile phase reservoir a high pressure pump; an injection valve (automatic sampler with an optional 25- μ L loop injector); a Zorbax ODS (DuPont Instruments, Wilmington, DE) reverse phase (RP) column, or equivalent (25-cm x 4.6-mm ID); a variable wavelength UV detector operating at 360 nm; and a data system, as illustrated in Figure 1.

[Note: Most commercial HPLC analytical systems will be adequate for this application.]

7.2 Cartridge sampler. Prepacked, pre-coated cartridge (see Figure 2), commercially available or coated *in situ* with DNPH according to Section 9.

[Note: This method was developed using the Waters Sep-Pak cartridge, coated in situ with DNPH on silica gel by the users, as delineated in the original Compendium Method TO-11 as a guideline. EPA has experience in use of this cartridge during various field monitoring programs over the last several years. Other manufacturer's cartridges should work as well. However, modifications to these procedures may be necessary if another commercially available cartridge is selected.]

Major suppliers of pre-coated cartridges are:

- Supelco, Supelco Park, Bellefonte, PA 16823-0048, (800) 247-6628.
- SKC Inc., 334 Valley View Road, Eighty Four, PA 15330-9614, (800) 752-8472.
- Millipore/Waters Chromatography, P.O. Box 9162, Marlborough, MA 01752-9748, (800) 252-4752.
- Atmospheric Analysis and Consulting (AAC) Inc., 4572 Telephone Rd., Suite 920, Ventura, CA 93003, (805) 650-1642.

[Note: The SKC cartridge (see Figure 2) is an example of a dual bed tube. The glass cartridge contains a front bed of 300 mg DNPH-coated silica gel with the back bed of 150 mg DNPH-coated silica gel. Air flow through the tube should be from front to back bed, as indicated by the arrows encribed on the cartridge. The dual bed tube cartridge may be used in atmospheres containing carbonyl concentrations in excess of the American Conference of Government Industrial Hygienists (ACGIH) 8-hour exposure limit, where breakthrough of carbonyls on the adsorbent might occur. If used in routine ambient air monitoring applications, the tube is recovered as one unit, as specified in Section 11.2.]

If commercially prepared DNPH-coated cartridges are purchased, ensure that a "Certification Blank for Formaldehyde" is provided for the specific batch of which that cartridge is a member. For a commercial cartridge to be acceptable, the following criteria must be met:

- Formaldehyde concentration: <0.15 µg/cartridge.

If the enhanced carbonyl analysis is being performed, the following Certification Blank criteria must also be met:

- Speciated carbonyl concentration:
 - Acetaldehyde: <0.10 µg/cartridge
 - Acetone: <0.30 µg/cartridge
 - Other: <0.10 µg/cartridge

Typical physical and chemical characteristics of commercial cartridge adsorbents are listed in Table 2 and illustrated in Figure 2.

7.3 Samplingsystem. the DNPH-cartridge approach is capable of accurately and precisely sampling 100-2000 mL/min of ambient air. The monitoring of carbonyl compounds has recently been enhanced by the promulgation of new ambient air quality surveillance regulations outlined in Title 40, Part 58. These regulations require States to establish additional air monitoring stations as part of their existing State Implementation Plan (SIP) monitoring network as part of EPA's Photochemical Assessment Monitoring Stations (PAMS) to include provisions for enhanced (1) monitoring of ozone and oxides of nitrogen (NO_x), (2) monitoring of volatile organic compounds (VOCs), (3) monitoring of meteorological parameters, and (4) monitoring selected carbonyl compounds (formaldehyde, acetone, and acetaldehyde). Specifically, monitoring for carbonyl involves:

- 8, 3 h sequential samples starting at midnight.
- 1, 24 h time-integrated "reality check" sample.

Consequently, the sampler must be able to accommodate numerous regulatory and practical needs. Practical needs would include:

- Ability to sequence two cartridges in series for breakthrough volume confirmation for a 24-hour sampling event.
- Ability to collocate with any of the 8, 3 h samples.

Traditionally, three sampling approaches have been used to monitor carbonyl compounds in the ambient air. They are:

- Manual single-port carbonyl sampler.
- Programmable single-port carbonyl sampler.
- Automated multi-port sampler.

Components of the single-port carbonyl sampler, for both manual and semi-automatic, are illustrated in Figure 3. Components usually include a heated manifold/sample inlet, a denuder/cartridge assembly, a flow meter, a vacuum gauge/pump, a timer and a power supply. In operation, ambient air is drawn through the denuder/cartridge assembly with a vacuum pump at a fixed flow rate between 0.1 to 2 Lpm. The vacuum gauge is used to measure the net vacuum in the system for all flow-rate corrections. Controlling the system is usually a 7-day, 14-event timer to coordinate sampling events to allow a sample to be extracted continuously or intermittently over a period of time. Finally, an elapsed-time counter is employed to measure the actual time the sampling took place. This is particularly suitable for unattended sampling when power fails for short periods.

The automated multi-port sampler is especially designed to collect numerous short-term (2 to 3 hours) sample sequentially over a 24 hour, 7 day a week, nighttime and weekend monitoring period. This arrangement allows for the sampling of short periods where the objectives of the project are to identify progress of atmospheric reactions involving carbonyls. As illustrated in Figure 4, components of the fully automated multi-port carbonyl sampler

includes a heated inlet, ozone denuder (or scrubber) inlet manifold assembly, inlet check valves, DNPH multi-port cartridge assembly, exhaust manifold, mass flow controller and sample pump. The multi-port sampler automatically switches between sampling ports at preselected times, as programmed by the user. Typically, a sequential air sampler contains a microprocessor timer/controller that provides precise control over each sampling event. The microprocessor allows the user to program individual start date and time, sample duration, and delays between samples. The timer also allows activation of the flow system prior (approximately 10 min) to sequencing to allow purging of the sampler inlet with fresh sample. Finally, the automated sequential sampler can be operated from an external signal, such as an ozone monitor, so that sampling starts above certain preset ozone levels or via a modem. As a final option, various manufacturers provide wind sensor instrumentation (wind speed and direction) which is connected to the automated sequential sampler so that sampling begins when the wind is from a preset direction and speed.

Major suppliers of commercially available carbonyl samplers are:

- Supelco, Supelco Park, Bellefonte, PA 16823-0048, (800) 247-6628.
- SKC Inc., 334 Valley View Road, Eighty Four, PA 15330-9614, (800) 752-8472.
- Millipore/Waters Chromatography, P.O. Box 9162, Marlborough, MA 01752-9748, (800) 252-4752.
- XonTech, Inc. 6862 Hayvenhurst Avenue, Van Nuys, CA 91406, (818) 787-7380.
- ATEC Atmospheric Technology, P.O. Box 8062, Calabasas, CA 91372-8062, (310) 457-2671.
- Atmospheric Analysis and Consulting (AAC) Inc., 4572 Telephone Road, Suite 920, Ventura, CA 93003, (805) 650-1642.
- Scientific Instrumentation Specialists, P.O. Box 8941, Moscow, ID, (209) 882-3860.

7.4 Stopwatch.

7.5 Polypropylene shipping container (see Figure 5) with polyethylene-air bubble padding. To hold sample cartridges.

7.6 Thermometer. To record ambient temperature.

7.7 Barometer (optional).

7.8 Volumetric flasks. Various sizes, 5-2000 mL.

7.9 Pipets. Various sizes, 1-50 mL.

7.10 Erlenmeyer flask, 1 L. For preparing HPLC mobile phase.

7.11 Graduated cylinder, 1 L. For preparing HPLC mobile phase.

7.12 Syringe, 100-250 μ L. For HPLC injection, with capacity at least four times the loop value.

7.13 Sample vials.

7.14 Melting point apparatus (optional).

7.15 Rotameters.

7.16 Calibrated syringes.

7.17 Soap bubble meter or wet test meter.

7.18 Mass flow meters and mass flow controllers. For metering/setting air flow rate through sample cartridge of 100-2000 mL/min.

[Note: The mass flow controllers are necessary because cartridges may develop a high pressure drop and at maximum flow rates, the cartridge behaves like a "critical orifice." Recent studies have shown that critical flow orifices may be used for 24-hour sampling periods at a maximum rate of 2 L/min for atmospheres not heavily loaded with particulates without any problems.]

7.19 Positive displacement. Repetitive dispensing pipets (Lab-Industries, or equivalent), 0-10 mL range.

7.20 Cartridge drying manifold. With multiple standard male Luer® connectors.

7.21 Liquid syringes. 10 mL (polypropylene syringes are adequate) for preparing DNPH-coated cartridges.

7.22 Syringe rack. Made of an aluminum plate (0.16 cm x 36 cm x 53 cm) with adjustable legs on four corners. A matrix (5 cm x 9 cm) of circular holes of diameter slightly larger than the diameter of the 10-mL syringes was symmetrically drilled from the center of the plate to enable batch processing of 45 cartridges for cleaning, coating, and/or sample elution.

7.23 Luer® fittings/plugs. To connect cartridges to sampling system and to cap prepared cartridges.

7.24 Hot plates, beakers, flasks, measuring and disposable pipets, volumetric flasks, etc. Used in the purification of DNPH.

7.25 Culture tubes (20 mm x 125 mm) with polypropylene screw caps. Used to transport coated cartridges for field applications (see Figure 5), Fisher Scientific, Pittsburgh, PA, or equivalent.

7.26 Polyethylene gloves. Used to handle cartridges, best source.

7.27 Dry test meter.

7.28 User-prepared copper tubing for ozone scrubber (see Figure 6a). A 36 inch length of ¼-inch O.D. copper tubing is used as the body of the ozone scrubber. The tubing should be coiled into a spiral approximately 2 inches in O.D. EPA has considerable field experience with the use of this denuder.

[Note: Ozone scrubbers (cartridge filled with granular KI) are also available from suppliers of pre-coated DNPH cartridges, as illustrated in Figure 6(b).]

7.29 Cord heater and Variac. A 24 inch long cord heater, rated at approximately 80 watts, wrapped around the outside of the copper coil denuder, controlled by a Variac, to provide heat (~50°C) to prevent condensation of water or organic compounds from occurring within the coil.

7.30 Fittings. Bulkhead unions are attached to the entrance and exit of the copper coil to allow attachment to other components of the sampling system.

8. Reagents and Materials

[Note: Purity of Reagents—Reagent grade chemicals shall be used in all tests. Unless otherwise indicated, it is intended that all reagents conform to the specifications of the Committee on Analytical Reagents of the American Chemical Society where such specifications are available; Purity of Water—Unless otherwise indicated, references to water shall be understood to mean reagent water as defined by Type II of ASTM Specifications D 1193.]

8.1 2,4-Dinitrophenylhydrazine (DNPH). Aldrich Chemical or J.T. Baker, reagent grade or equivalent. Recrystallize at least twice with UV grade acetonitrile before use.

8.2 DNPH coated cartridges. DNPH coated cartridge systems are available from several commercial suppliers.

8.3 High purity acetonitrile. UV grade, Burdick and Jackson "distilled-in-glass," or equivalent. The formaldehyde concentration in the acetonitrile should be <1.5 ng/mL. It is imperative (mandatory) that the user establish the purity of the acetonitrile before use (see Section 9.1).

8.4 Deionized-distilled water. Charcoal filtered.

8.5 Perchloric acid. Analytical grade, best source, 60%, specific gravity 1.51.

8.6 Ortho-phosphoric acid. Analytical grade, best source, 36.5-38%, specific gravity 1.19.

8.7 Formaldehyde. Analytical grade, best source, 37% solution (w/w).

8.8 Aldehydes and ketones, analytical grade, best source. Used for preparation of DNPH derivative standards (optional).

8.9 Carbonyl hydrazones. Formaldehyde and other carbonyl hydrazones are available for use as standards from commercial sources at various levels of purity.

8.10 Ethanol or methanol. Analytical grade, best source.

8.11 Nitrogen. High purity grade, best source.

8.12 Charcoal. Granular, best source.

8.13 Helium. High purity grade, best source.

8.14 Potassium Iodide. Analytical grade, best source. Used for coating inside of copper tubing of denuder system to remove ozone interference.

9. Preparation of Reagents and Cartridges

9.1 Purity of the Acetonitrile

9.1.1 The purity of acetonitrile is an important consideration in the determination of the formaldehyde blank concentration. Formaldehyde in the reagent will be quantitatively converted to the hydrazone and measured as part of the blank. The contribution to the blank from the reagent is dependent on the formaldehyde concentration in the reagent and the amount of the reagent used for extraction. Some examples will illustrate these considerations.

Example A

- Silica gel DNPH cartridge has a blank level of 60 ng.
- Cartridge is eluted with 5-mL of acetonitrile reagent containing a formaldehyde of 3 ng/mL.
- Analyst measures a blank level of 75 ng of which 80% comes from the cartridge and 20% comes from the reagent.

Example B

- Silica gel DNPH cartridge has a blank level of 30 ng.
- Cartridge is eluted with 5 mL of acetonitrile reagent containing a formaldehyde of 6 ng/mL.
- Analyst measures a blank level of 60 ng of which 50% comes from the cartridge and 50% comes from the reagent.

9.1.2 As a quality control procedure, the formaldehyde in the acetonitrile reagent should be checked on a regular basis. This can be done by mixing known proportions of the acetonitrile reagent and a DNPH solution having a measured formaldehyde blank. (The extract from a blank cartridge can serve as the DNPH solution.) After analyzing the resultant solution, a mass balance is performed on the observed formaldehyde level and the contribution from the DNPH reagent as shown in the following example.

- 1 mL of a DNPH solution containing 2.1 ng/mL of formaldehyde (as carbonyl) is mixed with 9 mL of acetonitrile reagent containing an unknown formaldehyde blank. The analyst measures a resultant solution concentration of 1.55 ng of formaldehyde. This data can be used to calculate the formaldehyde in the reagent:

$$\text{HCHO ng/mL} = \frac{(1.55 \text{ ng/mL} \times 10 \text{ mL} - 2.1 \text{ ng/mL} \times 1 \text{ mL})}{9 \text{ mL}} = 1.49 \text{ ng/mL}$$

The formaldehyde contribution to the cartridge blank should be as low as possible but certainly less than 20% of the total measured blank. Using a cartridge blank level of 30 ng/cartridge, the formaldehyde concentration in the reagent would have to be less than 1.5 ng/mL (i.e., 50 nM) to give a blank level less than 20% of the measured blank.

9.2 Purification of 2,4-Dinitrophenylhydrazine (DNPH)

[Note: This procedure should be performed under a properly ventilated hood, as inhalation of acetonitrile can result in nose and throat irritation. Various health effects are resultant from the inhalation of acetonitrile. At 500 ppm in air, brief inhalation has produced nose and throat irritation. At 160 ppm, inhalation for 4 hours has caused flushing of the face (2 hour delay after exposure) and bronchial tightness (5 hour delay). Heavier exposures have produced systemic effects with symptoms ranging from headache, nausea, and lassitude to vomiting, chest or abdominal pain, respiratory depression, extreme weakness, stupor, convulsions and death (dependent upon concentration and time).]

[Note: Purified DNPH, suitable for preparing cartridges, can be purchased commercially.]

9.2.1 Prepare a supersaturated solution of DNPH by boiling excess DNPH in 200 mL of acetonitrile for approximately one hour.

9.2.2 After one hour, remove and transfer the supernatant to a covered beaker on a hot plate and allow gradual cooling to 40-60°C.

9.2.3 Maintain the solution at this temperature (40-60°C) until 95% of solvent has evaporated.

9.2.4 Decant solution to waste, and rinse crystals twice with three times their apparent volume of acetonitrile.

9.2.5 Transfer crystals to another clean beaker, add 200 mL of acetonitrile, heat to boiling, and again let crystals grow slowly at 40-60°C until 95% of the solvent has evaporated.

9.2.6 Repeat rinsing process as described in Section 9.2.4.

9.2.7 Take an aliquot of the second rinse, dilute 10 times with acetonitrile, acidify with 1 mL of 3.8 M perchloric acid per 100 mL of DNPH solution, and analyze by HPLC.

[Note: An acid is necessary to catalyze the reaction of the carbonyls with DNPH. Most strong inorganic acids such as hydrochloric, sulfuric, phosphoric, or perchloric acids will do the job. Perchloric or phosphoric acids are the preferred catalyst for using acetonitrile solution of DNPH as the absorbing solution. The DNPH derivatives do not precipitate from solution as readily as when hydrochloric or phosphoric acids are used as the catalyst. This is an ideal situation for an HPLC analytical finish as this minimizes sample handling. For most ambient air sampling, precipitation is not a problem because the carbonyl concentration is generally in the ppb range.]

9.2.8 An impurity level of <0.15 µg/cartridge of formaldehyde in DNPH-coated cartridge is acceptable (based on the Certification Blank section 5.10). An acceptable impurity level for an intended sampling application may be defined as the mass of the analyte (e.g., DNPH-formaldehyde derivative) in a unit volume of the reagent solution equivalent to less than one tenth (0.1) the mass of the corresponding analyte from a volume of an air sample when the carbonyl (e.g., formaldehyde) is collected as DNPH derivative in an equal unit volume of the reagent solution. An impurity level unacceptable for a typical 10L sample volume may be acceptable if sample volume is increased to 100L. If the impurity level is not acceptable for intended sampling application, repeat recrystallization.

9.2.9 If the impurity level is not satisfactory, pipet off the solution to waste, then add 25 mL of acetonitrile to the purified crystals. Repeat rinsing with 20 mL portions of acetonitrile until a satisfactorily low impurity level in the supernatant is confirmed by HPLC analysis.

9.2.10 If the impurity level is satisfactory, add another 25 mL of acetonitrile, stopper and shake the reagent bottle, then set aside. The saturated solution above the purified crystals is the stock DNPH reagent.

9.2.11 Maintain only a minimum volume of saturated solution adequate for day to day operation. This will minimize wastage of purified reagent should it ever become necessary to re-rinse the crystals to decrease the level of impurity for applications requiring more stringent purity specifications.

9.2.12 Use clean pipets when removing saturated DNPH stock solution for any analytical applications. Do not pour the stock solution from the reagent bottle.

9.3 Preparation of DNPH-Formaldehyde Derivative

[Note: Purified crystals or solutions of DNPH-derivatives can be purchased commercially.]

9.3.1 To a portion of the recrystallized DNPH, add sufficient 2N HCl to obtain an approximately saturated solution. Add to this solution formaldehyde (other aldehydes or ketones may be used if their detection is desirable), in molar excess of the DNPH. Allow it to dry in air.

9.3.2 Filter the colored precipitate, wash with 2N HCl and water and let the precipitate air dry.

9.3.3 Check the purity of the DNPH-formaldehyde derivative by melting point determination or HPLC analysis. The DNPH-formaldehyde derivative should melt at 167°C ± 1°C. If the impurity level is not acceptable, recrystallize the

derivative in ethanol. Repeat purity check and recrystallization as necessary until acceptable level of purity (e.g., 99%) is achieved.

9.3.4 DNPH derivatives of formaldehyde and other carbonyls suitable for use as standards are commercially available both in the form of pure crystals and as individual or mixed stock solutions in acetonitrile.

9.4 Preparation of DNPH-Formaldehyde Standards

9.4.1 Prepare a standard stock solution of the DNPH-formaldehyde derivative by dissolving accurately weighed amounts in acetonitrile.

9.4.2 Prepare a working calibration standard mix from serial dilution of the standard stock solution. The concentration of the DNPH-formaldehyde compound in the standard mix solutions should be adjusted to reflect relative distribution in a real sample.

[Note: Individual stock solutions of approximately 100 mg/L are prepared by dissolving 10 mg of the solid derivative in 100 mL of acetonitrile. The individual solution is used to prepare calibration standards containing the derivative of interest at concentrations of 0.5-20 µg/mL, which spans the concentration of interest for most ambient air work.]

9.4.3 Store all standard solutions in a refrigerator. They should be stable at least one month.

9.4.4 DNPH-formaldehyde standards can also be purchased from various commercial suppliers. If purchased, ensure that a "Certification of Concentration" is provided.

9.5 Preparation of DNPH-Coated Cartridges

[Note: This procedure must be performed in an atmosphere with a very low aldehyde background. All glassware and plastic ware must be scrupulously cleaned and rinsed with deionized water and carbonyl free acetonitrile. Contact of reagents with laboratory air must be minimized. Polyethylene gloves must be worn when handling the cartridges. If the user wishes to purchase commercially prepared DNPH-coated cartridges, they are available from various vendors. If commercial prepared DNPH-coated cartridges are purchased, ensure that a "Certification Blank for Formaldehyde" is provided for the specific batch of which that cartridge is a member. For a commercial cartridge to be acceptable, the following criteria must be met:

- *Formaldehyde concentration: <0.15 µg/cartridge.*

If the enhanced carbonyl analysis is being performed, the following Certification Blank criteria must also be met:

- *Speciated carbonyl concentration:*
 - *Acetaldehyde: <0.10 µg/cartridge*
 - *Acetone: <0.30 µg/cartridge*
 - *Other: <0.10 µg/cartridge*

One who is not experienced in the preparation of DNPH-coated cartridge is strongly advised to use certified commercially available cartridges.]

9.5.1 DNPH Coating Solution

9.5.1.1 Pipet 30 mL of saturated DNPH stock solution to a 1000 mL volumetric flask, then add 500 mL acetonitrile.

9.5.1.2 Acidify with 1.0 mL of ortho-phosphoric acid (H₃PO₄).

[Note: The atmosphere above the acidified solution should preferably be filtered through a DNPH-coated cartridge to minimize contamination from laboratory air. Shake solution, then make up to volume with acetonitrile. Stopper the flask, invert and shake several times until the solution is homogeneous. Transfer the acidified solution to a reagent bottle with a 0-10 mL range positive displacement dispenser.]

9.5.1.3 Prime the dispenser and slowly dispense 10-20 mL to waste.

9.5.1.4 Dispense an aliquot solution to a sample vial, and check the impurity level of the acidified solution by HPLC according to Section 9.2.

9.5.1.5 The impurity level should be less than the Certification Blank of $<0.15 \mu\text{g}/\text{cartridge}$ for formaldehyde, similar to that in the DNPH coating solution.

9.5.2 Coating of Cartridges

9.5.2.1 Open the pre-packed cartridge package, connect the short end to a 10-mL syringe, and place it in a syringe rack (see Figure 7).

[Note: Prepare as many cartridges (~100) and syringes as possible.]

9.5.2.2 Using a positive displacement repetitive pipet, add 10 mL of acetonitrile to each of the syringes (see Figure 7).

9.5.2.3 Let liquid drain to waste by gravity.

[Note: Remove any air bubbles that may be trapped between the syringe and the silica cartridge by displacing them with the acetonitrile in the syringe.]

9.5.2.4 Set the repetitive dispenser containing the acidified DNPH coating solution to dispense 7 mL into the cartridges.

9.5.2.5 Once the effluent flow at the outlet of the cartridge has stopped, dispense 7 mL of the DNPH coating reagent into each of the syringes (see Figure 7).

9.5.2.6 Let the coating reagent drain by gravity through the cartridge until flow at the other end of the cartridge stops.

9.5.2.7 Wipe the excess liquid at the outlet of each of the cartridges with clean tissue paper.

9.5.2.8 Assemble a drying manifold with a scrubber or "guard cartridge" connected to each of the ports (see Figure 7). These "guard cartridges" are DNPH-coated and serve to remove any trace of formaldehyde in the nitrogen gas supply.

9.5.2.9 Insert cartridge connectors (flared at both ends, 0.64 by 2.5-cm outside diameter TFE-fluorocarbon FEP tubing with inside diameter slightly smaller than the outside diameter of the cartridge port) onto the long end of the scrubber cartridges.

9.5.2.10 Remove the cartridges from the syringes and connect the short ends to the exit end of the scrubber cartridge.

9.5.2.11 Pass nitrogen through each of the cartridges at about 300-400 mL/min for 5-10 minutes.

9.5.2.12 Within 10 minutes of the drying process, rinse the exterior surfaces and outlet ends of the cartridges with acetonitrile using a Pasteur pipet.

9.5.2.13 Stop the flow of nitrogen after 15 minutes, wipe the cartridge exterior free of rinsed acetonitrile and remove the dried cartridge.

9.5.2.14 Plug both ends of the coated cartridge with standard polypropylene Luer® male plugs, place the plugged cartridge in a shipping tube with polypropylene screw caps.

9.5.2.15 Put a serial number and a lot number label on each of the individual shipping tubes.

9.5.2.16 Store shipping tubes containing the DNPH-coated cartridges in a refrigerator at 4°C until use.

[*Note: Plugged cartridges may also be placed in screw-capped glass culture tubes and placed in a refrigerator until use. Cartridges will maintain their integrity for up to 90 days stored in refrigerated, capped shipping tubes.*]

9.5.2.17 Take a minimum of 3 blank cartridges from the cartridge batch and analyze for formaldehyde, as delineated in Section 11. The batch of user-prepared DNPH-coated cartridges is acceptable if the following criteria are met:

- Formaldehyde Certification Blank: <0.15 µg/cartridge.

If the enhanced carbonyl analysis is being performed, the following certification criteria must also be met:

- Speciated carbonyl concentration:
 - Acetaldehyde: <0.10 µg/cartridge
 - Acetone: <0.30 µg/cartridge
 - Other: <0.10 µg/cartridge

9.5.2.18 If analysis meets the above criteria, provide documentation with all cartridges associated with that batch involving "*Certification Blank for Formaldehyde.*" This certificate must be part of the project records.

9.5.2.19 If the cartridge results are close to, but above the Certification Blank, run a few more blank cartridges to check background level.

9.5.2.20 If analysis indicates failure of the cartridge, then *all* cartridges in that batch are unacceptable. Prepare a new batch of cartridges according to Section 9.5 until certification is achieved.

9.5.2.21 Store all certified cartridges in a refrigerator at 4 °C until use.

9.5.2.22 Before transport, remove the shipping container (or screw-capped glass culture tubes) containing the adsorbent tubes from the refrigerator and place culture tubes in a friction-top metal can containing 1-2 inches of charcoal for shipment to sampling location. Alternately, acidified DNPH-coated filters can be used in place of charcoal filters to remove impurity carbonyl compounds in the air.

9.5.2.23 As an alternative to friction-top cans for transporting sample cartridges, the coated cartridges could be shipped in their individual glass containers (see Figure 5a). A batch of coated cartridges may also be packed in a polypropylene shipping container for shipment to the field (see Figure 5b). The container should be padded with clean tissue paper or polyethylene-air bubble padding. Do not use polyurethane foam or newspaper as padding material.

9.5.2.24 The cartridges should be immediately stored in a refrigerator or freezer (<4 °C) upon arrival in the field.

9.6 Equivalent Formaldehyde Cartridge Concentration

9.6.1 One can calculate the equivalent formaldehyde background concentration (ppbv) contributed from a commercial or user-prepared DNPH-coated cartridge following exposure to formaldehyde-free air.

9.6.2 The equivalent formaldehyde background concentration includes the contribution of formaldehyde from both the acetonitrile and the cartridge.

9.6.3 Knowing the equivalent background concentration, as determined by the user (see Section 9.5.2) or supplied by the commercial supplier (see *Note*, Section 9.5), of formaldehyde in the cartridge (ng/cartridge), the formaldehyde background concentration contributed by the DNPH-coated cartridge (thus the method minimum detection limits) can be related to the total sample volume, as identified in Table 3.

9.6.4 For example, if the averaged background formaldehyde concentration supplied by the manufacturer is 70 ng/cartridge, then that cartridge can add 0.95 ppbv of equivalent formaldehyde, to the final ambient air concentration value, as delineated in Table 3 for a total air volume of 60 L.

9.6.5 The user should use DNPH-coated cartridges with the lowest background concentration to improve accuracy and detection limits.

10. Sampling Procedure

10.1 The sampling system is assembled and should be similar to that shown in Figures 3 and 4.

[Note: Figures 3 and 4 illustrate different tube/pump configurations. The tester should ensure that the pump is capable of constant flow rate throughout the sampling period.]

It is recommended that the sampling system employ a heated inlet (~50°C) coupled to an ozone denuder or scrubber to minimize water and ozone interference associated with the DNPH-coated adsorbent tube. Historically, the coated cartridges have been used as direct probes and traps for sampling ambient air when the ambient temperature was above freezing.

[Note: As illustrated in Figure 8, the ozone denuder has been effective for up to 80 hours without

breakthrough at ozone levels of approximately 700 ppb. Other studies have evaluated both denuders and scrubbers at ozone concentrations between 125 and 200 ppbv and found they have effectively removed ozone from the air stream for up to 100,000 ppb-hours; however, moisture was required (~10% RH) in the gas stream (26). The user should evaluate the length of time of the application of the denuder or scrubber to his field work. Caution should be utilized when using these devices for extensive periods of time at high humidity (>65%). Regarding the 24 hour samples, special caution should be taken while sampling nighttime periods when relative humidities approaching 100% are frequently encountered. It is recommended that routine schedule of ozone removal device replacement should be implemented as part of the sampling program.]

[Note: For sampling ambient air below freezing, a short length (30-60 cm) of heated (50-60°F) stainless steel tubing must be added to condition the air sample prior to collection on the DNPH-coated cartridges.]

10.2 Before sample collection, the system must be checked for leaks. Plug the inlet of the system so no flow is indicated at the output end of the pump. The mass flow meter should not indicate any air flow through the sampling apparatus.

10.3 Air flow through the DNPH-adsorbent cartridge may change during sampling as airborne particles deposit on the front of the cartridge. The flow change could be significant when sampling particulate-laden atmospheres. Particle concentrations greater than 50 ug/m³ are likely to represent a problem. For unattended or extended sampling periods, a mass flow controller is highly recommended to maintain constant flow. The mass flow controller should be set at least 20% below the maximum air flow through the cartridge.

10.4 The entire assembly (including a "test" sampling cartridge) is installed and the flow rate checked at a value near the desired sampling rate. In general, flow rates of 1,000-2,000 mL/min should be employed. The total sample volume should be selected to ensure that the collected formaldehyde concentration exceeds the background formaldehyde DNPH-cartridge concentration, as illustrated in Table 3. The total moles of carbonyl in the volume of air sampled should

not exceed that of the DNPH concentration (i.e., 2 mg cartridge). In general, a safe estimate of the sample size should be 75% of the DNPH loading of the cartridge.

[Note: If the user suspects that there will be breakthrough of a DNPH-coated cartridge during the sampling event, a backup cartridge should be used during the first sampling event. One would analyze the back-up cartridge for formaldehyde. If the back-up cartridge concentration exceeds 10% of the formaldehyde concentration on the front cartridge, then continue to use back-up cartridges in the monitoring program. However, if formaldehyde is not detected above the average blank level in the back-up cartridge after the first sampling event, then one can continue to use only one cartridge under normal representative conditions.]

[Note: The SKC tube is a dual bed configuration, allowing one to analyze the back bed (see Figure 2) for quantifying breakthrough.]

Generally, calibration is accomplished using a soap bubble flow meter or calibrated wet test meter connected to the flow exit, assuming the system is sealed.

[Note: ASTM Method D3686 describes an appropriate calibration scheme that does not require a sealed flow system downstream of the pump.]

10.5 The operator must measure and record the sampling flow rate at the beginning and end of the sampling period to determine sample volume. A dry gas meter may be included in the system to measure total sample volume and to compare against the in-line mass flow controller. Some commercial systems use flow monitors with data loggers to make these measurements.

10.6 Before sampling, flush the inlet (denuder/manifold, etc.) for approximately 15 min at the established flow rate to condition the system. Remove the glass culture tube from the friction-top metal can or styrofoam box. Let the cartridge warm to ambient temperature in the glass tube before connecting it to the sample train.

10.7 Using polyethylene gloves, remove the DNPH-coated cartridge from the shipping container and connect it to the sampling system with a Luer® adapter fitting. Most commercially available cartridges are bidirectional. However, review manufacturer suggestions for orientation of the cartridge to the inlet of the sampler.

[Note: If using the SKC dual bed tube, ensure the ambient air is pulled through the tube in the direction encribed on the tube by an arrow.]

Record the following parameters on Compendium Method TO-11A field test datasheet (FTDS), as illustrated in Figure 9: date, sampling location, time, ambient temperature, barometric pressure (if available), relative humidity (if available), dry gas meter reading (if appropriate), flow rate, rotameter setting, cartridge batch number, and dry gas meter pump identification numbers.

10.8 The sampler is turned on and the flow is adjusted to the desired rate. A typical flow rate through one cartridge is 1.0 L/min and 0.8 L/min for two tandem cartridges.

10.9 The sampler is operated for the desired period, with periodic recording of the variables listed in Figure 9.

10.10 If the ambient air temperature during sampling is below 15°C, a heated inlet probe is recommended. However, no pronounced effect of relative humidity (between 25% - 90%) has been observed for sampling under various weather

conditions--cold, wet, and dry winter months and hot and humid summer months. However, a negative bias has been observed when the relative humidity is <25%. At high humidity, the possibility of condensation must be guarded against, especially when sampling is in an air conditioned trailer.

10.11 At the end of the sampling period, the parameters discussed in Section 10.7 are recorded and the sample flow is stopped. If a dry gas meter is not used, the flow rate must be checked at the end of the sampling interval. If the flow rates at the beginning and end of the sampling period differ by more than 10%, the sample should be marked as suspect.

10.12 Immediately after sampling, remove the cartridge (using polyethylene gloves) from the sampling system, cap with Luer® end plugs, and place it back in the original labeled glass shipping container or culture tube. Cap, seal with TFE-fluorocarbon tape, and place it in appropriate padding. Refrigerate at 4°C until analysis. Refrigeration period prior to analysis should not exceed 2 weeks. If a longer storage period is expected, the cartridge should be extracted with 5 mL of acetonitrile (see Section 11.2.4 and 11.2.5) and the eluant placed in a vial for long term storage.

[Note: If samples are to be shipped to a central laboratory for analysis, the duration of the non-refrigerated period should be kept to a minimum, preferably less than two days.]

10.13 If a dry gas meter or equivalent total flow indicator is not used, the average sample flow rate must be calculated according to the following equation:

$$Q_A = \frac{Q_1 + Q_2 + \dots + Q_N}{N}$$

where:

Q_A = average flow rate, L/min.
 Q_1, Q_2, \dots, Q_N = flow rates determined at beginning, end, and intermediate points during sampling, L/min.
 N = number of points averaged.

10.14 The total flow rate is then calculated using the following equation:

$$V_m = (T_2 - T_1) \times Q_A$$

where:

V_m = total volume sampled at measured temperature and pressure, L.
 T_2 = stop time, minutes.
 T_1 = start time, minutes.
 $T_2 - T_1$ = total sampling time, minutes.
 Q_A = average flow rate, L/min.

10.15 The total volume (V_s) at EPA standard conditions, 25°C and 760 mm Hg, is calculated from the following equation:

$$V_s = V_m \times \frac{\bar{P}_A}{760} \times \frac{298}{273 + \bar{T}_A}$$

where:

- V_s = total sample volume at 25°C and 760 mm Hg pressure, L.
 V_m = total sample volume at measured temperature and pressure, L.
 \bar{P}_A = average ambient pressure, mm Hg.
 \bar{T}_A = average ambient temperature, °C.

11. Sample Analysis

11.1 Sample Preparation

11.1.1 The samples (trip blank, field blank and field samples) are returned to the laboratory in a shipping container and stored in a refrigerator at (<4°C) until analysis. Alternatively, the samples may also be stored alone in their individual containers.

11.1.2 The time between sampling and extraction should not exceed 2 weeks. Since background levels in the cartridges may change due to adsorption during storage, always compare field samples to their associated field and trip blank samples, stored under the same conditions.

11.2 Sample Extraction

[Note: Beware of unintentional exposure of samplers and eluted samples to aldehyde and ketone sources. Laboratory air often holds high concentrations of acetone. Labeling inks, adhesives, and packaging containers (including vials with plastic caps) are all possible sources on contamination.]

[Note: Contamination is most likely to occur during sample extraction. Before eluting derivatives, clean all glassware by rinsing with acetonitrile, then heating in a 60°C vacuum oven for at least 30 minutes. Eluting the samples in a nitrogen-purged glove bag further reduces the risk of contamination.]

The acetonitrile used to elute the DNPH derivatives is a typical source of contamination. Formaldehyde-free acetonitrile used to elute samples should be used only for this purpose, and stored in a carbonyl free environment. A concentration of 10 µg/L of any aldehyde or ketone in the acetonitrile adds 0.05 µg of that carbonyl to sample blank values if using 5 mL extraction volumes.]

11.2.1 Remove the sample cartridge from the labeled shipping tube or container. Connect the sample cartridge to a clean syringe. (Some commercial cartridges do not require the addition of a syringe for elution.)

[Note: The liquid flow during desorption should be in the reverse direction of air flow during sample collection.]

11.2.2 Place the sample cartridge syringe in the syringe rack (see Figure 7).

[Note: If the two beds in the SKC tube are being recovered separately for breakthrough studies, break the tube and place the beds in separate vials. Add exactly 5 mL of acetonitrile to each vial. Proceed with recovery, as specified in Section 11.2.4 through Section 11.2.5. Particulate in the relatively small number of samples used in the breakthrough studies should not adversely impact the sample valve or back pressure.]

11.2.3 Backflush the cartridge (gravity feed) by passing 5 mL of acetonitrile from the syringe through the cartridge to a 5-mL volumetric flask. The backflush elution approach may add particulate particles also collected on the cartridge to the acetonitrile solution which can cause sample valve failure and increase column back pressure. To minimize this, frontflush the cartridge contents with the acetonitrile reagent rather than backflush. The use of 5 mL of acetonitrile is sufficient for quantitative cartridge sample elution in either mode.

[Note: A dry cartridge has an acetonitrile holdup volume of about 0.3 mL. The eluant flow may stop before the acetonitrile in the syringe is completely drained into the cartridge because of air trapped between the cartridge filter and the syringe Luer® tip. If this happens, displace the trapped air with the acetonitrile in the syringe using a long-tip disposable Pasteur pipet.]

11.2.4 Dilute to the 5-mL mark with acetonitrile. Label the flask with sample identification. Store in refrigerated conditions until the sample is analyzed by HPLC. Pipet two aliquots into sample vials with TFE-fluorocarbon-lined septa. Analyze the first aliquot for the derivative carbonyls by HPLC. Store the second aliquot in the refrigerator until the results of the analysis of the first aliquot are complete and validated. The second aliquot can be used for confirmatory analysis, if necessary.

11.2.5 Sample eluates are stable at 4 °C for up to one month.

11.3 HPLC Analysis

11.3.1 The HPLC system is assembled and calibrated as described in Section 11.4. The operating parameters are as follows when formaldehyde is the only carbonyl of interest:

<u>Column:</u>	Zorbax ODS (4.6-mm ID x 25-cm), or equivalent.
<u>Mobile Phase:</u>	60% acetonitrile/40% water, isocratic.
<u>Detector:</u>	ultraviolet, operating at 360 nm.
<u>Flow Rate:</u>	1.0 mL/min.
<u>Retention Time:</u>	7 minutes for formaldehyde with one Zorbax ODS column. Thirteen minutes for formaldehyde with two Zorbax ODS columns.
<u>Sample Injection Volume:</u>	25 µL.

Before each analysis, the detector baseline is checked to ensure stable conditions.

11.3.2 The HPLC mobile phase is prepared by mixing 600 mL of acetonitrile and 400 mL of water. This mixture is filtered through a 0.22-µm polyester membrane filter in an all-glass and Teflon® suction filtration apparatus. The filtered mobile phase is degassed by purging with helium for 10-15 minutes (100 mL/min) or by heating to 60 °C for 5-10 minutes in an Erlenmeyer flask covered with a watch glass. A constant back pressure restrictor (350 kPa) or short length (15-30 cm) of 0.25-mm (0.01 inch) ID Teflon® tubing should be placed after the detector to eliminate further mobile phase outgassing.

11.3.3 The mobile phase is placed in the HPLC solvent reservoir and the pump is set at a flow rate of 1.0 mL/min and allowed to pump for 20-30 minutes before the first analysis. The detector is switched on at least 30 minutes before the first analysis, and the detector output is displayed on a strip chart recorder or similar output device. The isocratic flow of 60% acetonitrile/40% water is adequate for the analysis of formaldehyde; however, sufficient time between air sample analyses is required to assure that all other carbonyl compounds are eluted from the HPLC column prior to the next sample. The gradient flow approach, mentioned later (see Section 14.3) is properly programmed to elute other carbonyl compounds.

11.3.4 A 100- μ L aliquot of the sample is drawn into a clean HPLC injection syringe. The sample injection loop (25- μ L) is loaded and an injection is made. The data system, if available, is activated simultaneously with the injection. If a strip chart recorder is used, mark the point of injection on the chart paper.

11.3.5 After approximately one minute, the injection valve is returned to the "load" position and the syringe and valve are rinsed or flushed with acetonitrile/water mixture in preparation for the next sample analysis.

[Note: The flush/rinse solvent should not pass through the sample loop during flushing.]

The loop is cleaned while the valve is in the "load" mode.

11.3.6 After elution of the DNPH-formaldehyde derivative (see Figure 10), data acquisition is terminated and the component concentrations are calculated as described in Section 12.

11.3.7 After a stable baseline is achieved, the system can be used for further sample analyses as described above. Be sure to examine the chromatogram closely to ensure that background DNPH-formaldehyde derivative peaks are not on the solvent slope of the DNPH peak.

[Note: After several cartridge analyses, background buildup on the column may be removed by flushing with several column volumes of 100% acetonitrile.]

11.3.8 If the concentration of analyte exceeds the linear range of the instrument, the sample should be diluted with mobile phase, or a smaller volume can be injected into the HPLC.

11.3.9 If the retention time is not duplicated ($\pm 10\%$), the acetonitrile/water ratio may be increased or decreased to obtain the correct elution time. If the elution time is too long, increase the ratio; if it is too short, decrease the ratio. If retention time is not reproducing, the problem may be associated with the HPLC flow system. A control chart is recommended to evaluate retention time changes.

[Note: The chromatographic conditions described here have been optimized for the detection of formaldehyde. Analysts are advised to experiment with their HPLC system to optimize chromatographic conditions for their particular analytical needs. If a solvent change is necessary, always recalibrate before running samples.]

11.4 HPLC Calibration

11.4.1 Calibration standards can be prepared by the user in acetonitrile from the solid DNPH-formaldehyde derivative or liquid standards can be purchased from various manufacturers. From the solid compound, individual stock solutions of 100 μ g/mL are prepared by dissolving 10 mg of solid derivative in 100 mL of acetonitrile. Since the MW of HCHO-hydrazone is 210 g/mol, and the MW of HCHO is 30 g/mol, the stock solution concentration converts to 14.3 μ g/mL as formaldehyde ($30/210 \times 100 \mu\text{g/mL}$). The solid compound is weighed using a 5-place analytical balance and liquid dilutions are made with volumetric glassware. Stock solutions obtained from commercial suppliers generally range from 1 to 50 μ g/mL as the carbonyl compound. These stock solutions are typically provided in 1 mL ampules.

11.4.2 Using the stock solution, working calibration standards are produced. To generate the highest concentration working standard, use a pipette to quantitatively transfer 1.00 mL of the stock solution to a 25 mL volumetric flask. For example, using a 14.3 μ g/mL stock solution produces a working standard solution of 570 ng/mL

(14300 ng/mL x 1/25). The high concentration working standard diluted serially, using 1 to 5 mL pipettes and volumetric flasks, can produce working standards ranging between 28.5 and 570 ng/mL.

11.4.3 Each calibration standard (at least five levels) is analyzed three times and area response is tabulated against mass concentration injected (see Figure 11). All calibration runs are performed as described for sample analyses in Section 11.3. The results are used to prepare a calibration curve, as illustrated in Figure 12. The slope of the calibration curve gives the response factor, RF. Linear response is indicated where a correlation coefficient of at least 0.999 for a linear least-squares fit of the data (mass concentration versus area response) is obtained. The intercept of the calibration curve should pass through the origin. If it does not, check your reagents and standard solutions preparation procedure for possible contamination. If the calibration curve does not pass through the origin, the equation for the calibration curve should include the intercept.

11.4.4 Each new calibration curve should be verified by analyzing a standard prepared from material obtained from a second source. This standard should show a recovery of 85 to 115%. If not, corrective action is required to eliminate the discrepancy between the two sources of the standard material.

11.4.5 Once linear response has been documented, a concentration standard near the anticipated levels of each carbonyl component, but at least 10 times the detection limit, should be chosen for daily calibration. The day to day response for the various components should be within 10% of the calibration value. If greater variability is observed, prepare a fresh calibration check standard. If the variability using a freshly prepared calibration check standard is greater than 15% , a new calibration curve must be developed from fresh standards. A plot of the daily values on a Quality Control Chart (day versus concentration) is helpful to check for long term drift of the concentration value.

11.4.6 The response for each component in the daily calibration standard is used to calculate a response factor according to the following equation shown for formaldehyde:

$$R F_{\text{HCHO}} = \frac{(P - P_o)}{C_{\text{HCHO}}}$$

where:

RF_{HCHO} = response factor for formaldehyde given as area counts per ng/mL.

C_{HCHO} = concentration of analyte in the calibration standard in units of ng/mL.

P = peak area counts for the formaldehyde standard.

P_o = calibration curve intercept; in most cases this is zero.

11.4.7 The RF for each carbonyl compound is determined in the same way as that given for formaldehyde. The concentration of HCHO and other carbonyl compounds is determined with the calibration curves for each component in the analyzed sample. Example calculation for HCHO is given in section 12.

12. Calculations

Determination of the carbonyl compound air concentration requires three steps: (1) determination of the average blank and the standard deviation of the blank; (2) determination of the collected carbonyl compound mass of the cartridge; (3) calculation of the carbonyl compound air concentration. The following discussion provides these steps for formaldehyde.

12.1 Blank Determination

Since the blank level for any arbitrary cartridge is unknown, an average value for the blank is used in the calculation. As noted earlier, the average blank value is determined for each lot of cartridges. For a given lot size, N , a minimum of \sqrt{N} cartridge blanks (rounded to the next whole number) should be analyzed; i.e., for a lot size of

200, a minimum of $\sqrt{200}$ or 14 cartridge blanks should be analyzed. A minimum of 3 of these blanks are used for the Certification Blank, and the remaining 11 are used for field blanks. The mass of HCHO on each cartridge is determined by multiplying the observed peak area for blank cartridge solution by the acetonitrile extract volume (typically 5 mL) and dividing by the response factor as provided in the following equation:

$$M_{\text{BL-HCHO}_i} = \frac{P_{\text{BL-HCHO}_i} \times V_E}{R_{\text{HCHO}}}$$

where:

- $M_{\text{BL-HCHO}_i}$ = the blank HCHO mass for cartridge , i.
- R_{HCHO} = HCHO response factor calculated in Section 11.4.5.
- $P_{\text{BL-HCHO}_i}$ = area counts for HCHO in blank sample extract.
- V_E = extract volume in mL (usually 5 mL).

Once all blank cartridges have been measured, the average blank value is determined by the following equation:

$$\bar{M}_{\text{BL-HCHO}} = \frac{1}{N} \times \sum_{i=1}^N M_{\text{BL-HCHO}_i}$$

where:

- $\bar{M}_{\text{BL-HCHO}}$ = the average HCHO mass for all cartridges.
- $M_{\text{BL-HCHO}_i}$ = blank HCHO mass for cartridge, i.
- N = the number of blank cartridges.

[Note: Measurement of cartridge blanks should be distributed over the period that this particular cartridge lot is used for ambient air sampling. It is recommended that a trend plot of blank results be constructed to evaluate background carbonyl results over the period of cartridge lot utilization in the sampling program. If significant drifting is observed, blank average values should be segmented to be more representative of carbonyl background.]

12.2 Carbonyl Analyte Mass

The calculation equation for the mass of the collected carbonyl compounds on an individual cartridge is the same as that for the cartridge blanks. The gross measured carbonyl mass is determined with an equation analogous to that given in section 12.1. The equation for formaldehyde is given as:

$$M_{\text{SA}_i} = \frac{P_{\text{SA}_i} \times V_E}{R_{\text{HCHO}}}$$

where:

- M_{SA_i} = gross HCHO mass for cartridge, i.
- P_{SA_i} = HCHO peak area counts for cartridge, I.

RF_{HCHO} = the response factor for HCHO.

V_E = acetonitrile extract volume in mL (typically 5 mL).

The net HCHO mass for an individual cartridge is determined by subtracting the average blank value from the gross HCHO mass obtained for sample i , and is given as:

$$M_{\text{HCHO}_i} = M_{\text{S A}_i} - \bar{M}_{\text{BL-HCHO}}$$

12.3 Carbonyl Compound Concentration

The sample air concentration for carbonyl compounds cannot be determined directly from the mass measurement and requires conversion to units of volume. The conversion calculation for HCHO is determined using the ideal gas law and is given by the following equation:

$$V_{\text{HCHO}_i} = \frac{M_{\text{HCHO}_i}}{\text{MW}} \times (R \times T_{\text{AMB}}) \times \frac{760}{P_{\text{AMB}}}$$

where:

V_{HCHO_i} = gas volume of HCHO on cartridge, i .

M_{HCHO_i} = mass of HCHO on cartridge, i .

MW = molecular weight of HCHO, 30.03 g/mole.

R = gas constant, 0.082 L-atm/mol-deg.

T_{AMB} = ambient air temperature in degrees Kelvin, $273 + T$ ($^{\circ}\text{C}$).

P_{AMB} = ambient air pressure in torr.

For an ambient air temperature of 25°C and a pressure of 760 torr, the ideal law equation reduces to:

$$V_{\text{HCHO}_i} = 1.2276 \times M_{\text{HCHO}_i}$$

In this equation, the HCHO mass in ng is converted to a volume in nL. The volume of air that was passed through the cartridge was measured by either a mass flow controller or dry test meter calibrated at a known temperature and pressure. To determine HCHO concentration in the units of ppbv, apply the following equation:

$$C_{\text{HCHO ppbv}} = \frac{V_{\text{HCHO}_i}}{V_{\text{AIR}}}$$

where:

$$\begin{aligned}V_{\text{HCHO}_i} &= \text{volume of formaldehyde in nL} \\V_{\text{AIR}} &= \text{volume of sample air through the cartridge}\end{aligned}$$

13. Performance Criteria and Quality Assurance

This section summarizes required quality assurance measures and provides guidance concerning performance criteria that should be achieved within each laboratory.

13.1 Standard Operating Procedures (SOPs).

13.1.1 Users should generate SOPs describing the following activities in their laboratory: (1) assembly, calibration, and operation of the sampling system, with make and model of equipment used; (2) preparation, purification, storage, and handling of sampling reagent and samples; (3) assembly, calibration, and operation of the HPLC system, with make and model of equipment used; and (4) all aspects of data recording and processing including lists of computer hardware and software used.

13.1.2 SOPs should provide specific stepwise instructions and should be readily available to and understood by the laboratory personnel conducting the work.

13.2 HPLC System Performance

13.2.1 The general appearance of the HPLC system should be similar to that illustrated in Figure 1.

13.2.2 HPLC system efficiency is calculated according to the following equation:

$$N = 5.54 \left(\frac{t_r}{W_{1/2}} \right)^2$$

where:

N = column efficiency, theoretical plates.

t_r = retention time of analyte, seconds.

$W_{1/2}$ = width of component peak at half height, seconds.

A column efficiency of >5,000 theoretical plates should be utilized.

13.2.3 Precision of response for replicate HPLC injections should be $\pm 10\%$ or less, day to day, for analyte calibration standards at 150 ng/mL or greater levels (as the carbonyl compound). At 75 ng/mL levels and below, precision of replicate analyses could vary up to 25%. Precision of retention times should be $\pm 7\%$ on a given day.

13.3 Process Blanks

13.3.1 At least one field blank should be used for each day of field sampling, shipped and analyzed with each group of samples. The number of samples within a group and/or time frame should be recorded so that a specified minimum number of blanks is obtained for a given cartridge lot used for field samples. The field blank is treated identically to the samples except that no air is drawn through the cartridge. The performance criteria described in Section 9.2 should be met for field blanks. It is also desirable to analyze trip and laboratory blank cartridges as well, to distinguish between possible field and lab contamination.

[Note: Remember to use the field blank value for each cartridge lot when calculating concentration. Do not mix cartridge lots in the blank value determinations.]

13.4 Method Precision and Accuracy

13.4.1 At least 50% of the sampling events should include a collocated sample. A collocated sample is defined as a second sampling port off the common sampling manifold. If more than five samples are collected per sampling event, a collocated sample should be collected for each sampling event. Precision for the collocated samples should be $\pm 20\%$ or better. EPA historical data has demonstrated effectiveness in reaching $\pm 20\%$, as illustrated in Figure 13.

13.4.2 Precision for replicate HPLC injections should be $\pm 10\%$ or better, day to day, for calibration standards.

13.4.3 Cartridges spiked with analytes of interest can be used in round-robin studies to intercompare several laboratories performing carbonyl analyses. The spiked samples are prepared in the laboratory by spiking a blank cartridge with a solution of derivatized carbonyls in acetonitrile. The laboratory preparing the spike samples should analyze at a minimum 3 of the prepared spiked samples to evaluate the consistency of prepared samples.

13.4.4 Before initial use of the method, each laboratory should generate triplicate spiked samples at a minimum of three concentration levels, bracketing the range of interest for each compound. Triplicate nonspiked samples must also be processed. Spike recoveries of $>80 \pm 10\%$ and blank levels should be achieved.

13.4.5 For ambient air sampling, an ozone denuder must be used as part of the sampling system. As discussed in Section 6.4, ozone effects the ultimate method precision and accuracy by reacting with its carbonyl derivative (hydrazones) on the cartridge. To illustrate this point, Figure 14 documents the concentration of formaldehyde captured on collocated DNPH-cartridges, one with a denuder (see Figure 14a) and the other without a denuder (see Figure 14b). The formaldehyde peak is considerably higher with use of an ozone denuder.

13.5 Method Detection Limits

13.5.1 Determine method detection limits using the procedures in 40 CFR Part 136B. Prepare a low level standard of the carbonyl derivatives at a concentration within two to five times the estimated method detection limit. Inject the standard into the analytical system seven times.

13.5.2 Calculate the measured concentration using the calibration curve.

13.5.3 Determine the standard deviation for the seven analyses and use the standard deviation to calculate the detection limit as described in 40 CFR Part 136B.

13.6 General QA/QC Requirements

13.6.1 General QA/QC requirements associated with the performance of Compendium Method TO-11A include:

Sampling

- Each sampling event, flow calibration with bubble meter, both pre- and post-checks.
- Mass flow meter calibration factor determined every quarter.
- Each sampling event, leak check, both pre- and post-checks.
- 10 percent of field samples collocated to help calculate method precision and evaluate biases.
- 10 percent of field samples operated with back-up cartridge to evaluate analyte breakthrough.
- Field and trip (optional) blank cartridges are included with each field sample collection program.
- Sample volumes calculated and reviewed project QA officer.

Reagents

- Coating solution prepared from concentrated stock solution immediately before each coating.

- Solution analyzed before each coating to determine acceptability (less than 0.15 µg/cartridge for each aldehyde), control chart of contaminant concentration maintained.
- Three blank cartridges per lot for immediate elution/analysis to determine Certification Blank for the carbonyl compounds.

Analysis

- Multi point calibration curve performed each six months.
- Each initial calibration verified with a standard from a second source.
- Continuing calibration standard (mid-level) analyses every analytical run to evaluate precision, peak resolution and retention time drift.
- Method detection limits (MDLs) verified annually or after each instrument change.
- Replicate analysis of approximately 10 percent of sample eluents to evaluate precision.
- Samples quantitated against least squares calibration line.
- Performance evaluation (PE) sample acquired from independent sources analyzed prior to and after field samples.
- Random collocated samples shipped to independent laboratory for analysis and compared to in-house collocated sample.
- Testing of acetonitrile used for sample extraction for background carbonyl evaluation.

Data Acquisition

- Sample chromatograms and standards checked daily for peak shape and integration quality, resolution of carbonyls, overall sensitivity and retention time drift.
- Separate tape backups made of raw data immediately after completion of each analysis.
- Peaks in each sample checked for correct ID and integration using system software before export to ASCII file.
- Final results checked and edited by project QA officer before producing final report.
- Tape backups of final data files produced.

13.6.2 All results should be reviewed by the project QA officer, independent of the field and laboratory operations, to evaluate the overall adherence to the methodology in meeting the program data quality objectives (DQOs).

14. Detection of Other Aldehydes and Ketones

14.1 Introduction

14.1.1 The procedure outlined above has been written specifically for the sampling and analysis of formaldehyde in ambient air using an adsorbent cartridge and HPLC. Ambient air contains other aldehydes and ketones. Optimizing chromatographic conditions by using two Zorbax ODS columns in series and varying the mobile phase composition through a gradient program will enable the analysis of other aldehydes and ketones. Alternatively, other aldehydes and ketones may also be analyzed using a single C-18, reverse phase column and a ternary gradient as described by Waters or Smith, et al. (*J. Chromatography*, 483, 1989, 431-436). Thus, other aldehydes and ketones can be detected with a modification of the basic procedure.

14.1.2 In particular, chromatographic conditions can be optimized to separate acetaldehyde, acetone, propionaldehyde, and some higher molecular weight carbonyls within an analysis time of about 1 h by utilizing two Zorbax ODS columns in series, and a linear mobile phase program. Operating the HPLC in a gradient mode with one Zorbax ODS column may also provide adequate resolution and separation. Carbonyl compounds covered within the scope of this modification include:

Formaldehyde	Crotonaldehyde	
<i>o</i> -Tolualdehyde		
Acetaldehyde	Butyraldehyde	
<i>m</i> -Tolualdehyde		
Acetone	Benzaldehyde	
<i>p</i> -Tolualdehyde		
Propionaldehyde	Isovaleraldehyde	
Hexanaldehyde		
Valeraldehyde	2,5-Dimethylbenzaldehyde	Methyl ethyl ketone

14.1.3 The linear gradient program varies the mobile phase composition periodically to achieve maximum resolution of the C-3, C-4 and benzaldehyde region of the chromatogram. The following gradient program was found to be adequate to achieve this goal: Upon sample injection, linear gradient from 65% acetonitrile (ACN)/35% water to 55% ACN/45% water in 36 min; to 100% ACN in 20 min; 100% ACN for 5 min; reverse linear gradient from 100% ACN to 60% ACN/40% water in 1 min; maintain at 60% ACN/40% water for 15 min.

14.2 Sampling Procedures

Same as Section 10.

14.3 HPLC Analysis

14.3.1 The HPLC system is assembled and calibrated as described in Section 11. The operating parameters are as follows:

- Column: Zorbax ODS, two columns in series
- Mobile Phase: Acetonitrile/water, linear gradient
 - Step 1. 60-75% acetonitrile/40-25% water in 30 minutes.
 - Step 2. 75-100% acetonitrile/25-0% water in 20 minutes.
 - Step 3. 100% acetonitrile for 5 minutes.
 - Step 4. 60% acetonitrile/40% water reverse gradient in 1 minute.
 - Step 5. 60% acetonitrile/40% water, isocratic, for 15 minutes.
- Detector: Ultraviolet, operating at 360 nm
- Flow Rate: 1.0 mL/min
- Sample Injection Volume: 25 μ L

14.3.2 The gradient program allows for optimization of chromatographic conditions to separate acetaldehyde, acetone, propionaldehyde, and other higher molecular weight aldehydes and ketones in an analysis time of about one hour.

14.3.3 The chromatographic conditions described here have been optimized for a gradient HPLC system equipped with a UV detector (variable wavelength), an automatic sampler with a 25- μ L loop injector and two DuPont Zorbax ODS columns (4.6 x 250-mm), a recorder, and an electronic integrator. Analysts are advised to experiment with their HPLC systems to optimize chromatographic conditions for their particular analytical needs. Highest chromatographic resolution and sensitivity are desirable but may not be achieved. The separation of acetaldehyde, acetone, and propionaldehyde should be a minimum goal of the optimization.

14.3.4 The carbonyl compounds in the sample are identified and quantified by comparing their retention times and area counts with those of standard DNPH derivatives. Formaldehyde, acetaldehyde, acetone, propionaldehyde, crotonaldehyde, benzaldehyde, and *o*-, *m*-, *p*-tolualdehydes can be identified with a high degree of confidence. The

identification of butyraldehyde is less certain because it coelutes with isobutyraldehyde and is only partially resolved from methyl ethyl ketone under the stated chromatographic conditions. A typical chromatogram obtained with the gradient HPLC system for detection of other aldehydes and ketones is illustrated in Figure 15.

14.3.5 The concentrations of individual carbonyl compounds are determined as outlined in Section 12.

14.3.6 Performance criteria and quality assurance activities should meet those requirements outlined in Section 13.

15. Precision and Bias

15.1 This test method has been evaluated by round robin testing. It has also been used by two different laboratories for analysis of over 1,500 measurements of formaldehyde and other aldehydes in ambient air for EPA's Urban Air Toxics Program (UATP), conducted in 14 cities throughout the United States.

15.2 The precision of 45 replicate HPLC injections of a stock solution of formaldehyde-DNPH derivative over a 2-month period has been shown to be 0.85% relative standard deviation (RSD).

15.3 Triplicate analyses of each of twelve identical samples of exposed DNPH cartridges provided formaldehyde measurements that agreed within 10.9% RSD.

15.4 A total of 16 laboratories in the U.S., Canada, and Europe participated in a round robin test that included 250 blank DNPH-cartridges, three sets of 30 cartridges spiked at three levels with DNPH derivatives, and 13 sets of cartridges exposed to diluted automobile exhaust gas. All round robin samples were randomly distributed to the participating laboratories. A summary of the round robin results is shown in Table 4.

15.5 The absolute percent differences between collocated duplicate sample sets from the 1988 UATP program were 11.8% for formaldehyde ($n=405$), 14.5% for acetaldehyde ($n=386$), and 16.7% for acetone ($n=346$).

15.6 Collocated duplicate samples collected in the 1989 UATP program and analyzed by a different laboratory showed a mean RSD of 0.07, correlation coefficient of 0.98, and bias of -0.05 for formaldehyde. Corresponding values for acetaldehyde were 0.12, 0.95 and -0.54, respectively. In the 1988 UATP program, single laboratory analyses of spiked DNPH cartridges provided over the year showed an average bias of +6.2% for formaldehyde ($n=14$) and +13.8% for acetaldehyde ($n=13$).

15.7 Single laboratory analyses of 30 spiked DNPH cartridges during the 1989 UATP program showed an average bias of +1.0% (range -49 to +28%) for formaldehyde and 5.1% (range -38% to +39%) for acetaldehyde.

16. References

1. Riggin, R. M., "Determination of Aldehydes and Ketones in Ambient Air: Method TO-5," in *Compendium of Methods for the Determination of Toxic Organic Compounds in Ambient Air*, U. S. Environmental Protection Agency, EPA-600/4-84-041, Research Triangle Park, NC, April 1984.
2. Winberry, W. T. Jr., et al., "Determination of Formaldehyde and Other Aldehydes in Indoor Air Using Passive Sampling Device, Method IP-6C," in *Compendium of Methods for the Determination of Air Pollutants in Indoor Air*, U. S. Environmental Protection Agency, EPA-600/4-90-010, May 1990.
3. Tejada, S.B., "Standard Operating Procedure For DNPH-coated Silica Cartridges For Sampling Carbonyl Compounds In Air And Analysis by High-performance Liquid Chromatography," Unpublished, U. S. Environmental Protection Agency, Research Triangle Park, NC, March 1986.

4. Tejada, S.B., "Evaluation of Silica Gel Cartridges Coated *in situ* with Acidified 2,4-Dinitrophenylhydrazine for Sampling Aldehydes and Ketones in Air," *Intern. J. Environ. Anal. Chem.*, Vol. 26:167-185, 1986.
5. Winberry, W. T. Jr., et al., "Determination of Formaldehyde in Ambient Air Using Adsorbent Cartridge Followed by HPLC: Method TO-11," in *Compendium of Methods for the Determination of Toxic Organic Compounds in Ambient Air, Second Supplement*, U. S. Environmental Protection Agency, EPA-600/4-89-018, Research Triangle Park, NC, March 1989.
6. Winberry, W. T. Jr., et al., "Determination of Formaldehyde and Other Aldehydes in Indoor Air Using a Solid Adsorbent Cartridge: Method IP-6A," in *Compendium of Methods for the Determination of Air Pollutants in Indoor Air*, U. S. Environmental Protection Agency, EPA-600/4-90-010, May 1990.
7. Nolan, L., et al., "Monitoring Carbonyls in Ambient Air Using the New Supelclean™ LPD (Low Pressure Drop) DNPH Cartridge," in *Proceedings of the 1995 EPA/AWMA International Symposium on Measurement of Toxic and Related Air Pollutants*, VIP-50, pp. 279, May 1995.
8. *Quality Assurance Handbook for Air Pollution Measurement Systems, Volume II - Ambient Air Specific Methods*, EPA-600/R-94-038b, U. S. Environmental Protection Agency, Research Triangle Park, NC, May 1994.
9. *Technical Assistance Document for Sampling and Analysis of O₃ Precursors*, U. S. Environmental Protection Agency, EPA-600/8-9-215, Research Triangle Park, NC, October 1991.
10. Ahonen, I., Priha, E., and Aijala, M-L, "Specificity of Analytical Methods Used to Determine the Concentration of Formaldehyde in Workroom Air," *Chemosphere*, Vol. 13:521-525, 1984.
11. Levin, J. O., et al., "Determination of Sub-part-per-Million Levels of Formaldehyde in Air Using Active or Passive Sampling on 2,4-Dinitrophenylhydrazine-Coated Glass Fiber Filters and High-Performance Liquid Chromatography," *Anal. Chem.*, Vol. 57:1032-1035, 1985.
12. Perez, J. M., Lipari, F., and Seizinger, D. E., "Cooperative Development of Analytical Methods for Diesel Emissions and Particulates - Solvent Extractions, Aldehydes and Sulfate Methods", presented at the *Society of Automotive Engineers International Congress and Exposition*, Detroit, MI, February-March 1984.
13. Kring, E. V., et al., "Sampling for Formaldehyde in Workplace and Ambient Air Environments-Additional Laboratory Validation and Field Verification of a Passive Air Monitoring Device Compared with Conventional Sampling Methods," *J. Am. Ind. Hyg. Assoc.*, Vol. 45:318-324, 1984.
14. Sirju, A., and Shepson, P. B., "Laboratory and Field Evaluation of the DNPH-Cartridge Technique for the Measurement of Atmospheric Carbonyl Compounds," *Environ. Sci. Technol.* Vol. 29:384-392, 1995.
15. Chasz, E. et al., "Philadelphia Air Management Lab, Summary of Procedures and Analytical Data for Enhanced Ambient Monitoring of PAMS Carbonyls," in *Proceedings of the 1995 EPA/AWMA International Symposium on Measurement of Toxic and Related Air Pollutants*, VIP-50, pp. 293, May 1995.
16. Grosjean, D., "Ambient Levels of Formaldehyde, Acetaldehyde, and Formic Acid in Southern California: Results of a One-Year Base-Line Study," *Environ. Sci. Technol.*, Vol. 25, 710-715, 1991.

17. Bufalini, J.J., and Brubaker, K.L., "The Photooxidation of Formaldehyde at Low Pressures." In: *Chemical Reaction in Urban Atmospheres*, (C.S. Tuesday), American Elsevier Publishing Co., New York, pp. 225-240. 1971.
18. Altshuller, A.P., and Cohen, I.R., "Photooxidation of Formaldehyde in the Presence of Aliphatic Aldehydes", *Science*, Vol. 7:1043-1049, 1963.
19. "Formaldehyde and Other Aldehydes," Committee on Aldehydes, Board of Toxicology and Environmental Hazards, National Research Council, National Academy Press, Washington, DC, 1981.
20. Altshuller, A. P., "Production of Aldehydes as Primary Emissions and Secondary Atmospheric Reactions of Alkenes and Alkanes During the Night and Early Morning Hours," *Atmos. Environ.*, Vol. 27A:21-31, 1993.
21. Tanner, R. L., et al., "Atmospheric Chemistry of Aldehydes; Enhanced PAN Formation From Ethanol Fuel Vehicles," *Environ. Sci. Technol.*, Vol. 22:1026-1034, 1988.
22. Ciccioli, P., and Cecinato, A., "Advanced methods for the Evaluation of Atmospheric Pollutants Relevant to Photochemical Smog and Dry Acid Deposition: Chapter 11" in *Gaseous Pollutants: Characterization and Cycling*, edited by Jerome O. Nriagu, ISBN 0-471-54898-7, John Wiley and Sons, Inc., 1992.
23. Parmar, S. S., et al., "A Study of Ozone Interferences in Carbonyl Monitoring Using DNPH Coated C₁₈ and Silica Cartridges," in *Proceedings of the 1995 EPA/AWMA International Symposium on Measurement of Toxic and Related Air Pollutants*, VIP-50, pp. 306, May 1995.
24. Parmar, S. S., et al., "Effect of Acidity on the Sampling and analysis of Carbonyls Using DNPH Derivatization Method," in *Proceedings of the 1996 EPA/AWMA International Symposium on Measurement of Toxic and Related Air Pollutants*, VIP-64, pp. 311, May 1996.
25. Arnts, R. R., and Tejada, S. B., "2,4-Dinitrophenylhydrazine-Coated Silica Gel Cartridge Method for Determination of Formaldehyde in Air: Identification of an Ozone Interference," *Environ. Sci. Technol.* Vol. 23:1428-1430, 1989.
26. Kleindienst, T. E., et al., "Measurement of C₁-C₄ Carbonyls on DNPH-Coated Silica Gel and C₁₈ Cartridges in the Presence of Ozone," in *Proceedings of the 1995 EPA/AWMA International Symposium on Measurement of Toxic and Related Air Pollutants*, VIP-50, pp 29T, May 1995.

TABLE 1. COMPARISON OF DNPH COATED CARTRIDGES: SILICA GEL VS. C18

Topic	Comparison	Discussion
Background	Silica gel < C18	Silica gel is purer, therefore less background contamination from acetone and formaldehyde as compared to C18.
Breakthrough	Silica gel < C18	C18 allows carbonyl compounds to breakthrough easier with longer sampling periods, thus causing bias results. C18 has a lower capacity for carbonyls in general. Loading of DNPH on C18 plays an important role in breakthrough for carbonyls.
Ozone interference	Silica gel C18	Ozone interference with silica gel is documented. Ozone interference with C18 is not clear at this time. Therefore, must use denuder with both systems.
Extraneous chromatographic peaks	Silica gel C18	Researchers have detected extraneous peaks in the chromatography of both C18 and silica gel when ozone is present.

TABLE 2. TYPICAL DNPH-CARTRIDGE SPECIFICATIONS

Category	Typical Specifications
Adsorbent	chromatographic grade silica or C18 coated with 2,4-dinitrophenylhydrazine (DNPH)
Particle size	150-1000 μm (60/100 mesh to 18/35 mesh)
DNPH loading ¹	0.3-0.9% (~1-3 mg/cartridge)
Bed weight ²	approx. 350 mg
Capacity	approx. 75 μg formaldehyde, assuming a 50% consumption of DNPH
Background (per cartridge)	<0.15 μg formaldehyde <0.10 μg acetaldehyde <0.10 μg other carbonyls <0.30 μg acetone
Pressure drop	7 inches of water @ 0.5 L/min 15 inches of water @ 1.0 L/min 37 inches of water @ 2.0 L/min
Sampling temperature	10°C to 100°C
Collection efficiency	>95% for formaldehyde for sampling rates up to 2.0 L/min
Solvent hold-up volume	~1.0 mL
Tube dimensions	From ~2 inches to ~5 inches in length ~1 inch O.D. at widest point

¹Loading is variable among commercial suppliers.

²The SKC tube is a dual bed cartridge with 300 mg of DNPH-coated silica gel in the front bed and 150 mg of DNPH-coated silica gel in the back bed.

TABLE 3. EQUIVALENT FORMALDEHYDE CONCENTRATION (ppbv) RELATED TO BACKGROUND FORMALDEHYDE CONCENTRATION (ng/cartridge)

Equivalent formaldehyde concentration (ppbv)	Sample volume, L			
	60	120	180	1440
formaldehyde cartridge concentration ng/cartridge				
70	0.950	0.475	0.317	0.040
100	1.358	0.679	0.453	0.057
150	2.037	1.018	0.679	0.085

TABLE 4. ROUND ROBIN TEST RESULTS^a

Sample Type	Formaldehyde	Acetaldehyde	Propionaldehyde	Benzaldehyde
Blank cartridges:				
µg aldehyde	0.13	0.18	0.12	0.06
(% RSD)	46	70	47	44
n	33	33	23	8
Spiked ^b cartridges:				
% recovery (% RSD)				
low				
medium	89.0 (6.02)	92.6 (13.8)	108.7 (32.6)	114.7 (36.1)
high	97.2 (3.56)	97.8 (7.98)	100.9 (13.2)	123.5 (10.4)
n	97.5 (2.15)	102.2 (6.93)	100.1 (6.77)	120.0 (8.21)
	12	13	12	14
Exhaust samples:				
µg aldehyde	5.926	7.990	0.522	0.288
% RSD	12.6	16.54	26.4	19.4
n	31	32	32	17

^aSixteen participating laboratories. Statistics shown after removal of outliers.

^bNormal spiking levels were approximately 0.5, 5 and 10 µg of aldehyde, designated as low, medium, and high in this table.

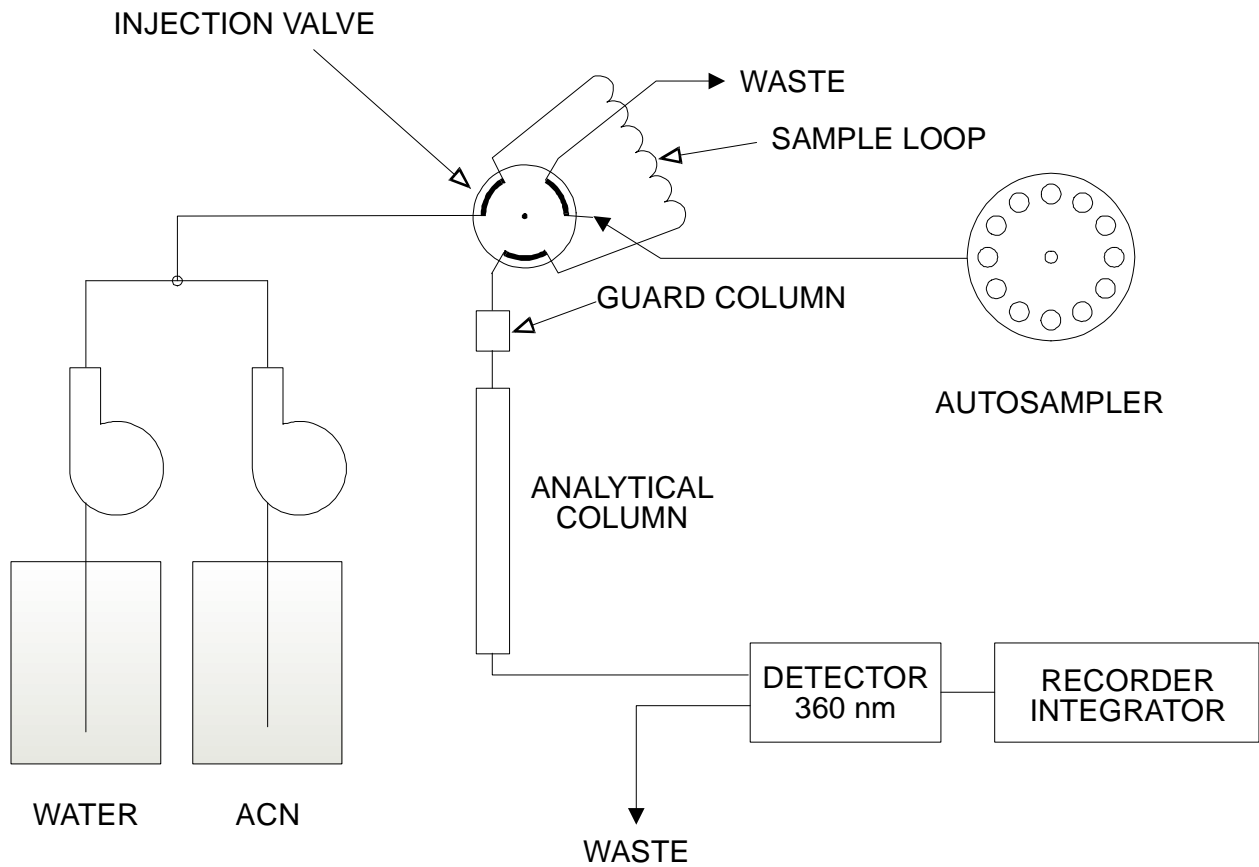

Figure 1. Basic high-performance liquid chromatographic (HPLC) system used for carbonyl analysis.

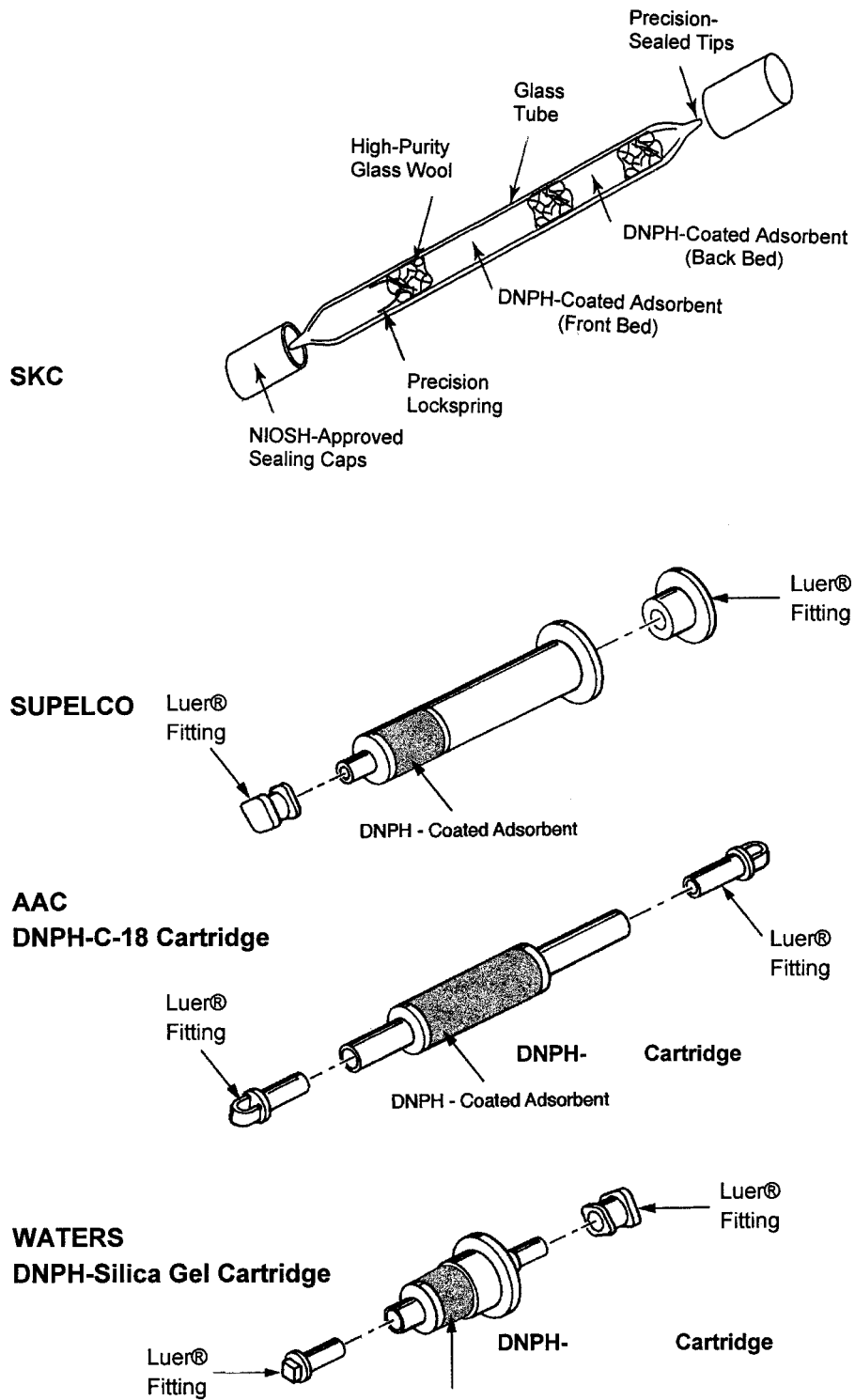

Figure 2. Example of commercially available DNPH-cartridges.

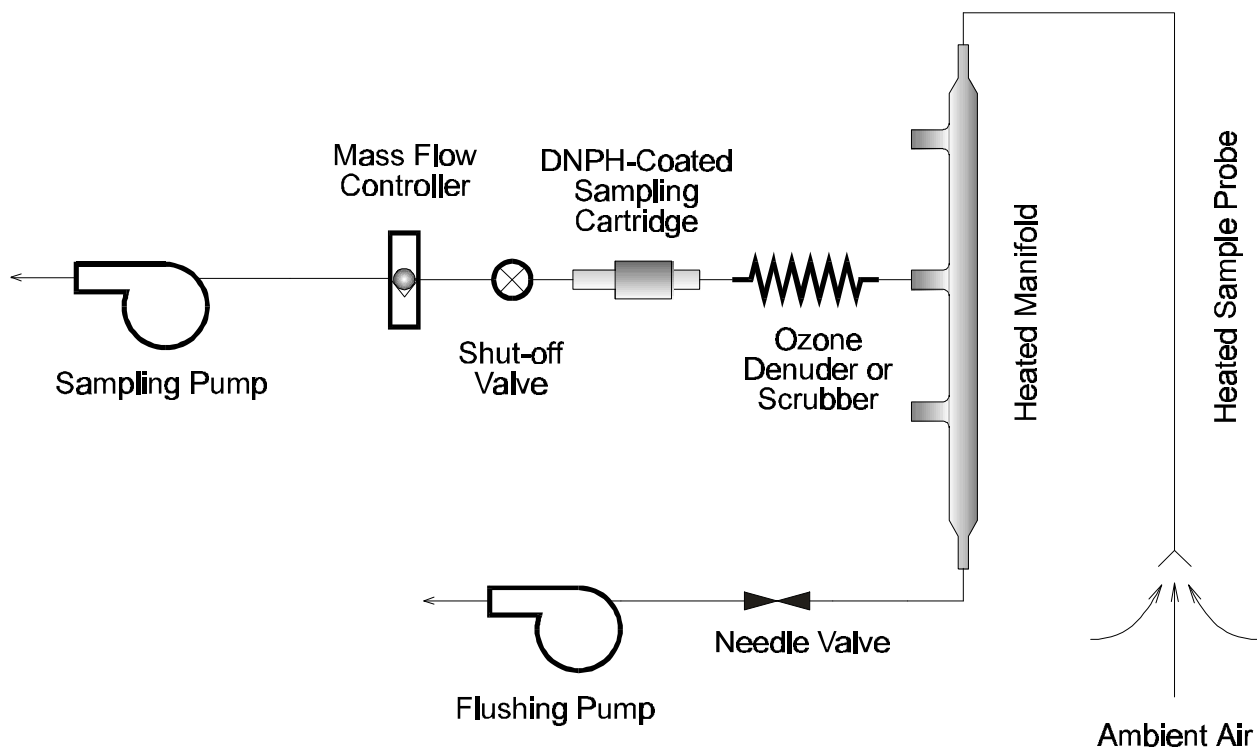

Figure 3. Example of configuration of a single-port carbonyl sampler using DNPH-coated cartridges.

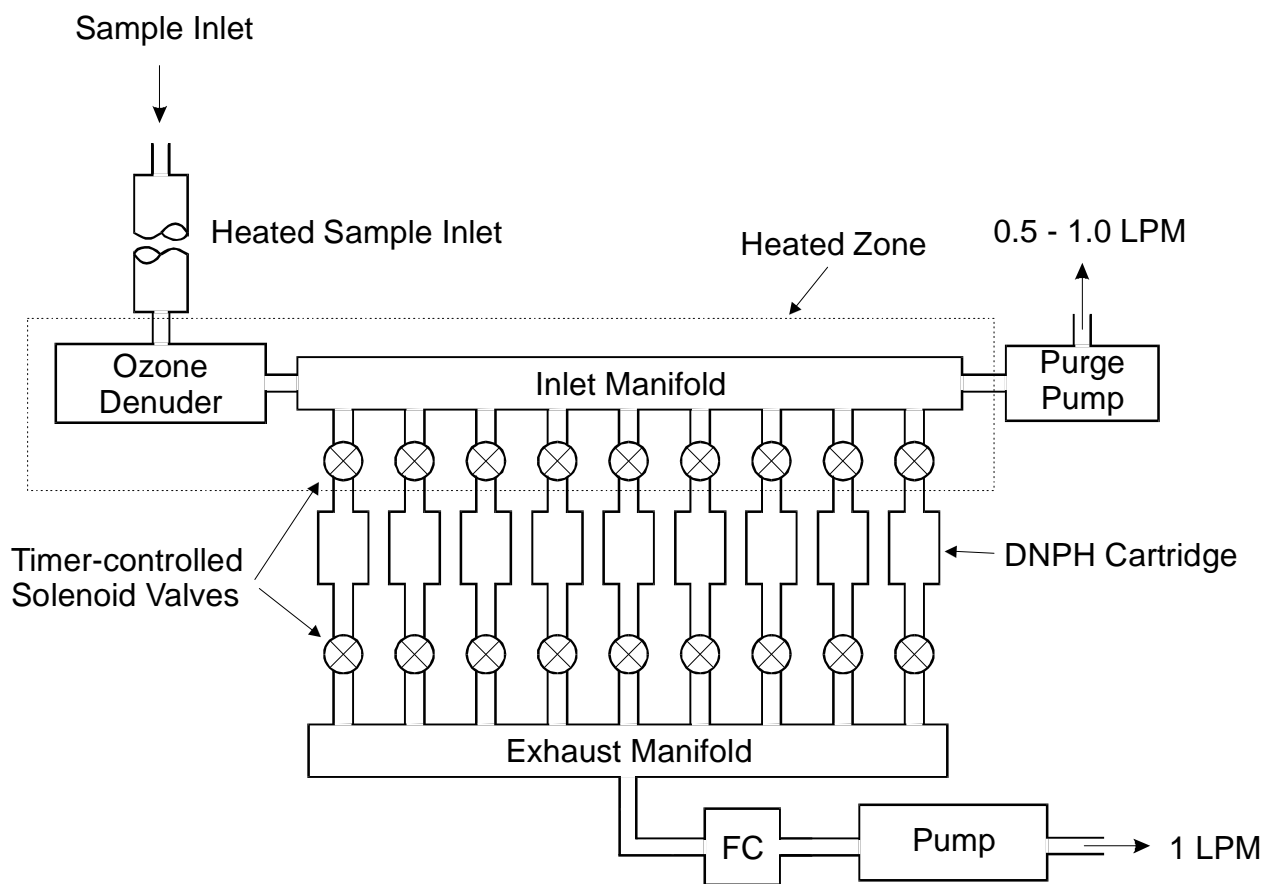

Figure 4. Example of components of an automated multi-port sampler for carbonyls monitoring using DNPH-coated cartridges.

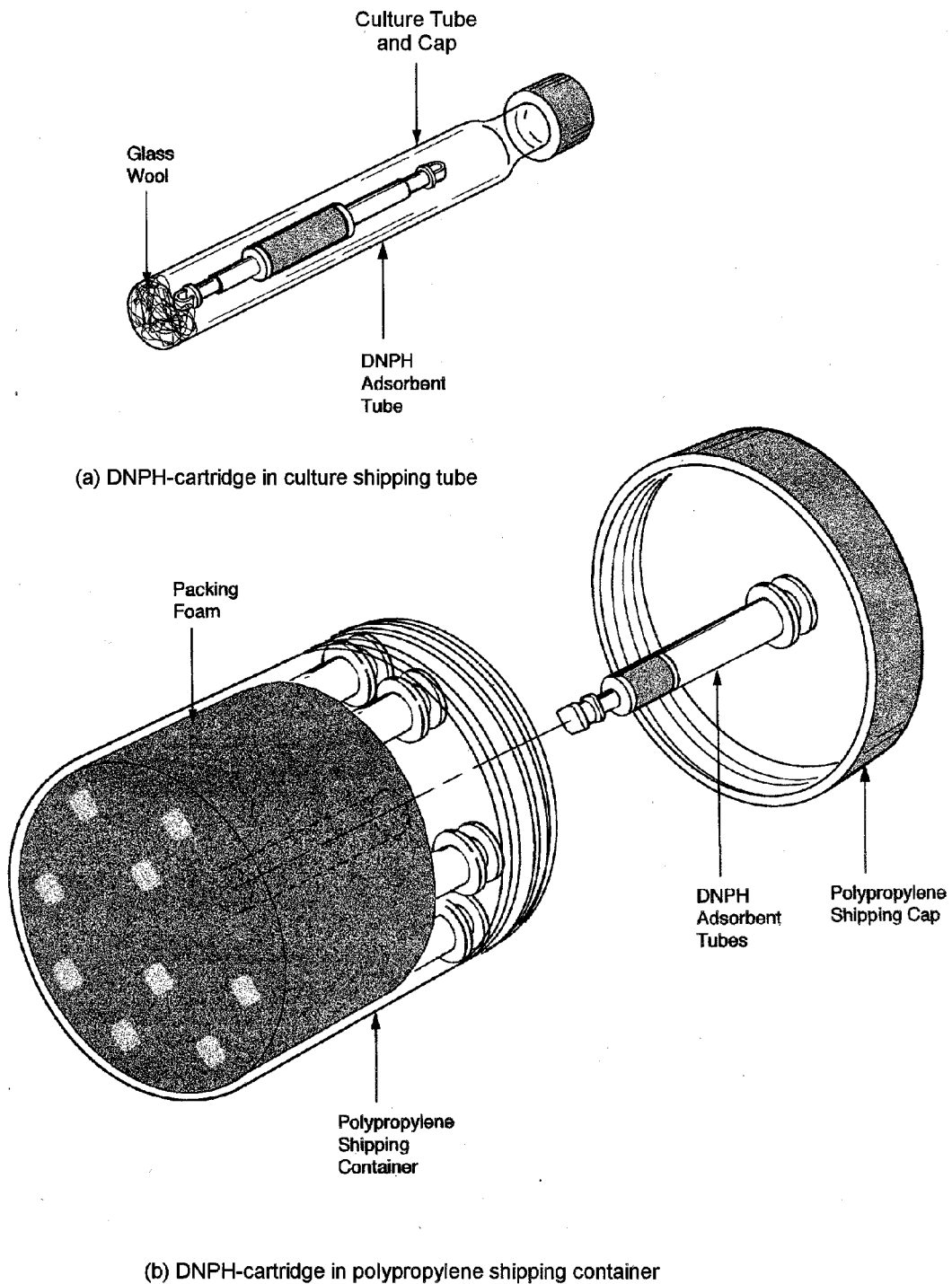
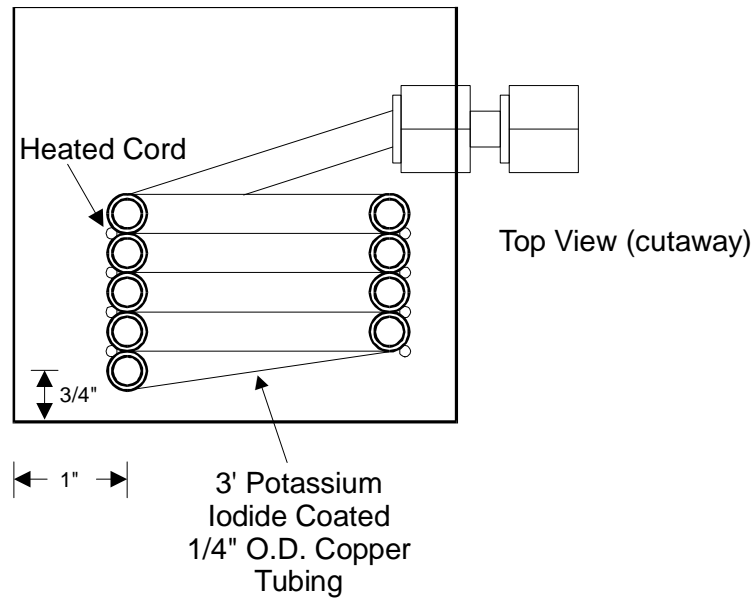
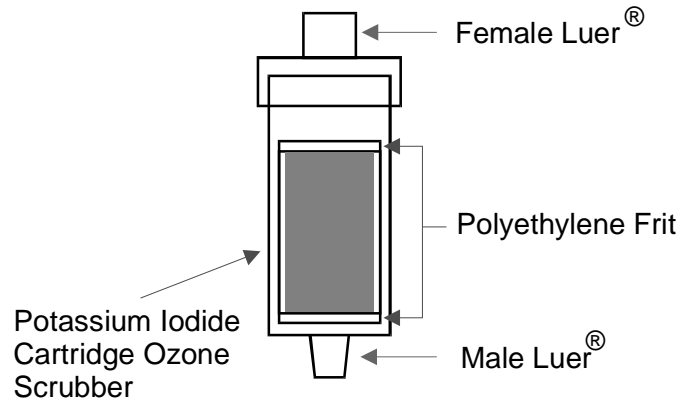

Figure 5. Example of commercially available shipping containers for DNP cartridges.



(a) Cross-sectional view of EPA's ozone denuder assembly



(b) Commercially available packed granular potassium iodide (KI) ozone scrubber

Figure 6. Example of (a) cross-sectional view of EPA's ozone denuder assembly, and (b) commercially available packed granular potassium iodide (KI) ozone scrubber.

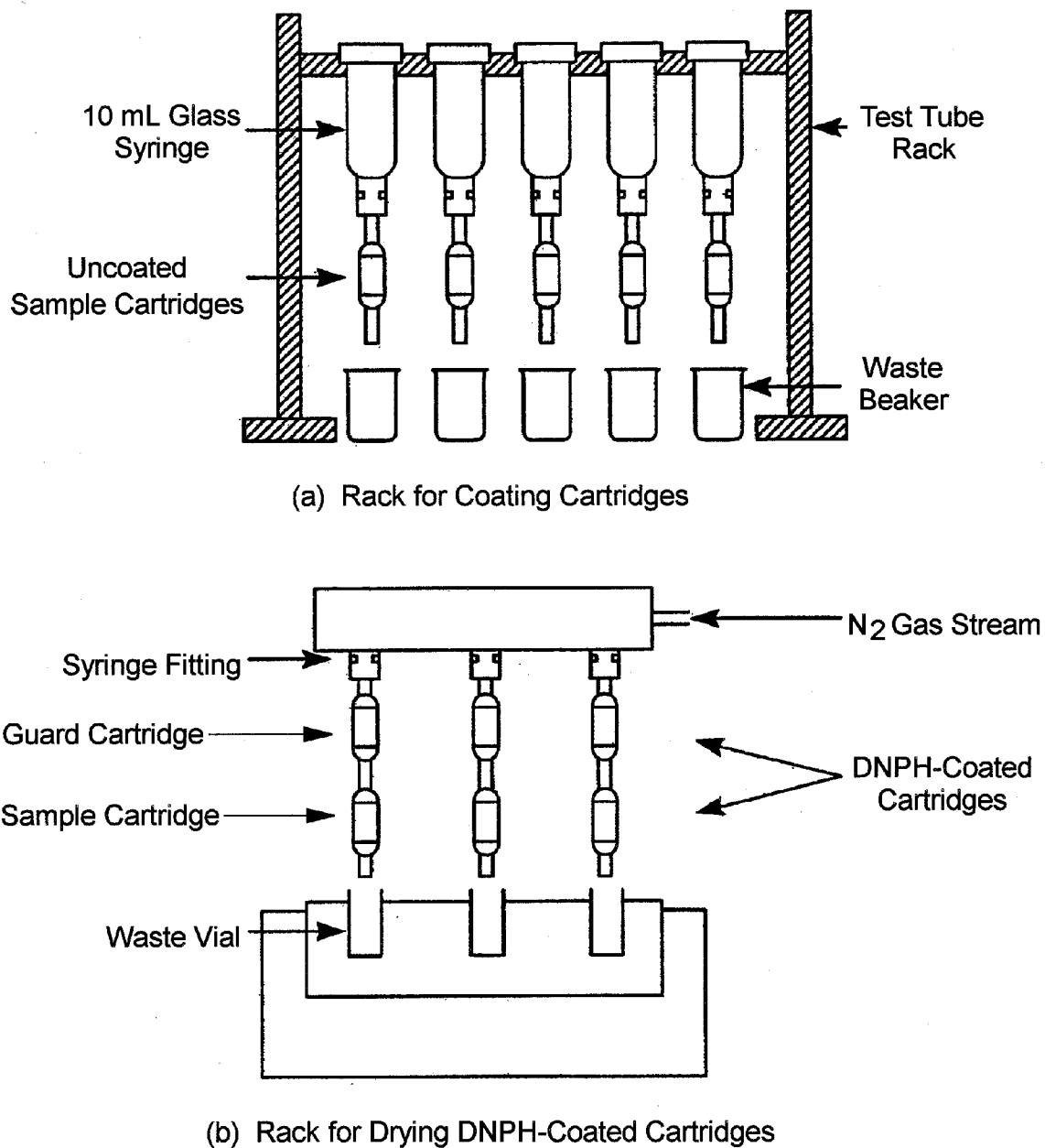

Figure 7. Example of a typical syringe rack for coating (a) and drying (b) sample cartridges.

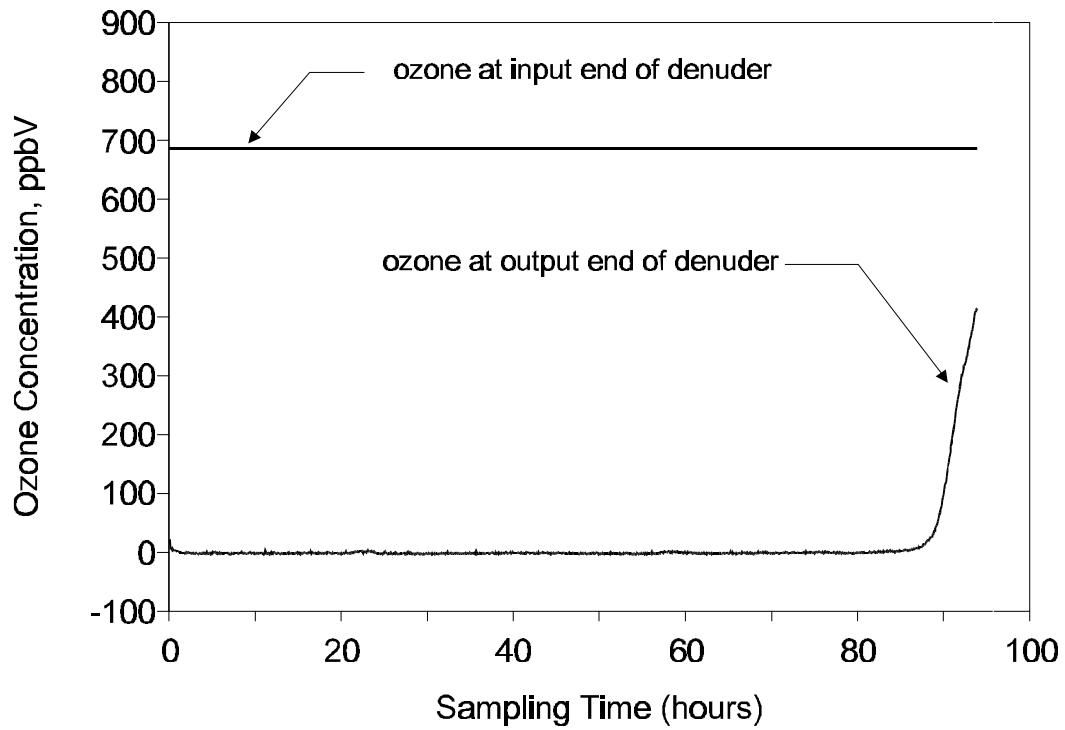

Figure 8. Example of capacity of 3' x 0.25" O.D. x 4.6-mm I.D. copper KI ozone denuder at 2 L/min flow.

COMPENDIUM METHOD TO-11A
 CARBONYL SAMPLING FIELD TEST DATA SHEET
 (One Sample per Data Sheet)

I. GENERAL INFORMATION

PROJECT: _____
 SITE: _____
 LOCATION: _____
 INSTRUMENT MODEL NO.: _____
 PUMP SERIAL NO.: _____
 ADSORBENT CARTRIDGE INFORMATION:
 Type: _____
 Adsorbent: _____
 Serial Number: _____
 Sample Number: _____

DATES(S) SAMPLED: _____
 TIME PERIOD SAMPLED: _____
 OPERATOR: _____
 CALIBRATED BY: _____
 OZONE DENUDEUR USE TIME (Hr): _____
 HEATED INLET: ____ YES ____ NO

II. SAMPLING DATA INFORMATION

Start Time: _____

Stop Time: _____

Time	Dry Gas Meter Reading	Rotameter Reading	Flow Rate, *Q mL/min	Ambient Temperature, °C	Barometric Pressure, mm Hg	Relative Humidity, %	Comments
Avg.							

* Flow rate from rotameter or soap bubble calibrator (specify which).
 Total Volume Data (V_m) (use data from dry gas meter, if available)

$$V_m = (\text{Final} - \text{Initial}) \text{ Dry Gas Meter Reading, or} = \text{_____ L}$$

or

$$V_m = \frac{Q_1 + Q_2 + Q_3 \dots Q_N}{N} \times \frac{1}{1000 \times (\text{Sampling Time in Minutes})} = \text{___ L}$$

III. COMMENTS

Figure 9. Example of Compendium Method TO-11A field test data sheet (FTDS).

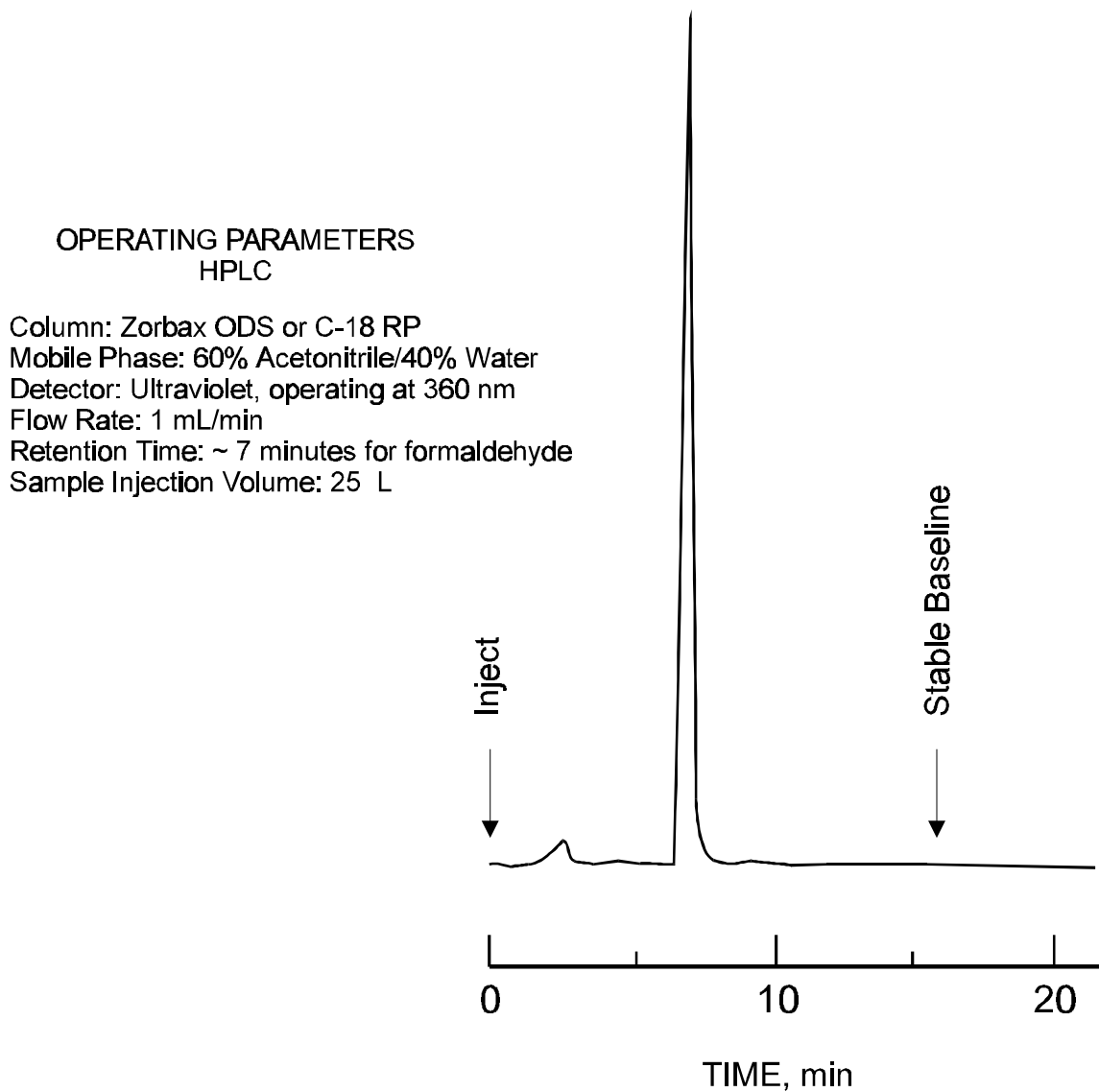

Figure 10. Example of chromatogram of DNPH-formaldehyde derivative.

OPERATING PARAMETERS HPLC

Column: Zorbax ODS or C-18 RP
 Mobile Phase: 60% Acetonitrile/40% Water
 Detector: Ultraviolet, operating at 360 nm
 Flow Rate: 1 mL/min
 Retention Time: ~ 7 minutes for formaldehyde
 Sample Injection Volume: 25 μ L

Peak	Conc., μ g/mL	Area Counts
a	0.61	226541
b	1.23	452186
c	6.16	2257271
d	12.32	4711408
e	18.48	6053812

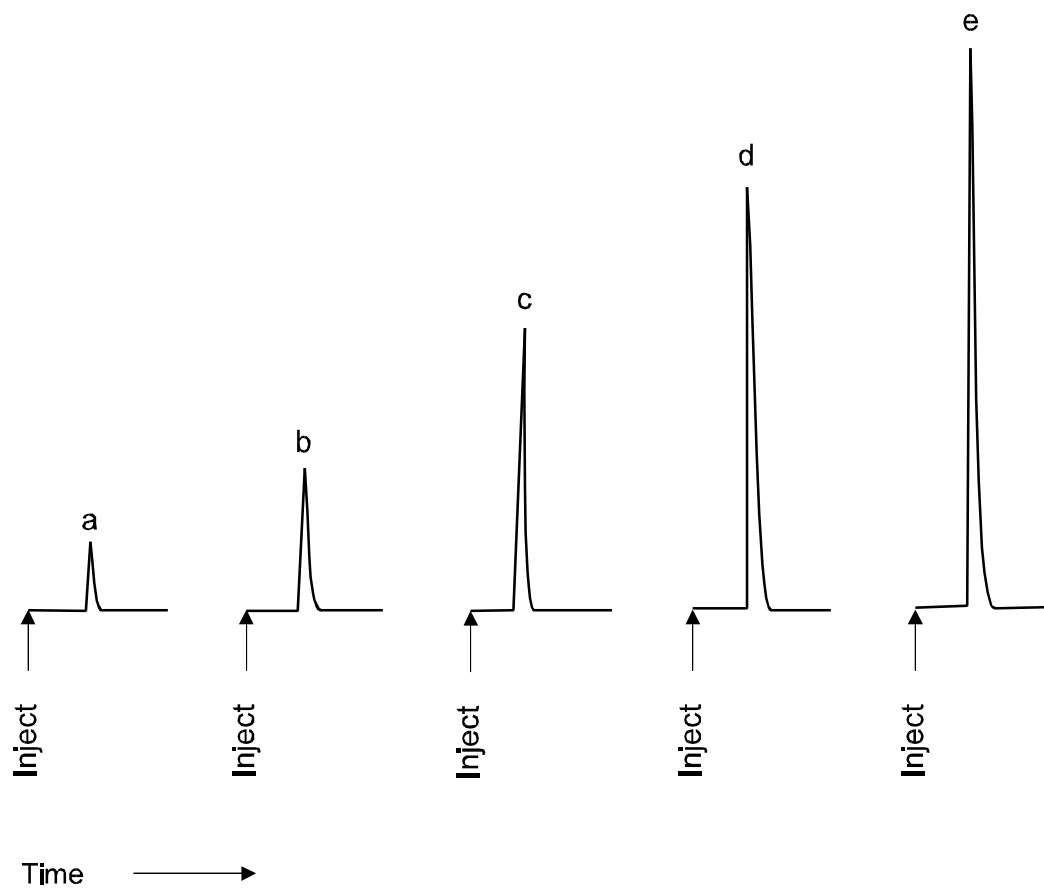

Figure 11. Example of HPLC chromatogram of varying concentration of DNP-H formaldehyde derivative.

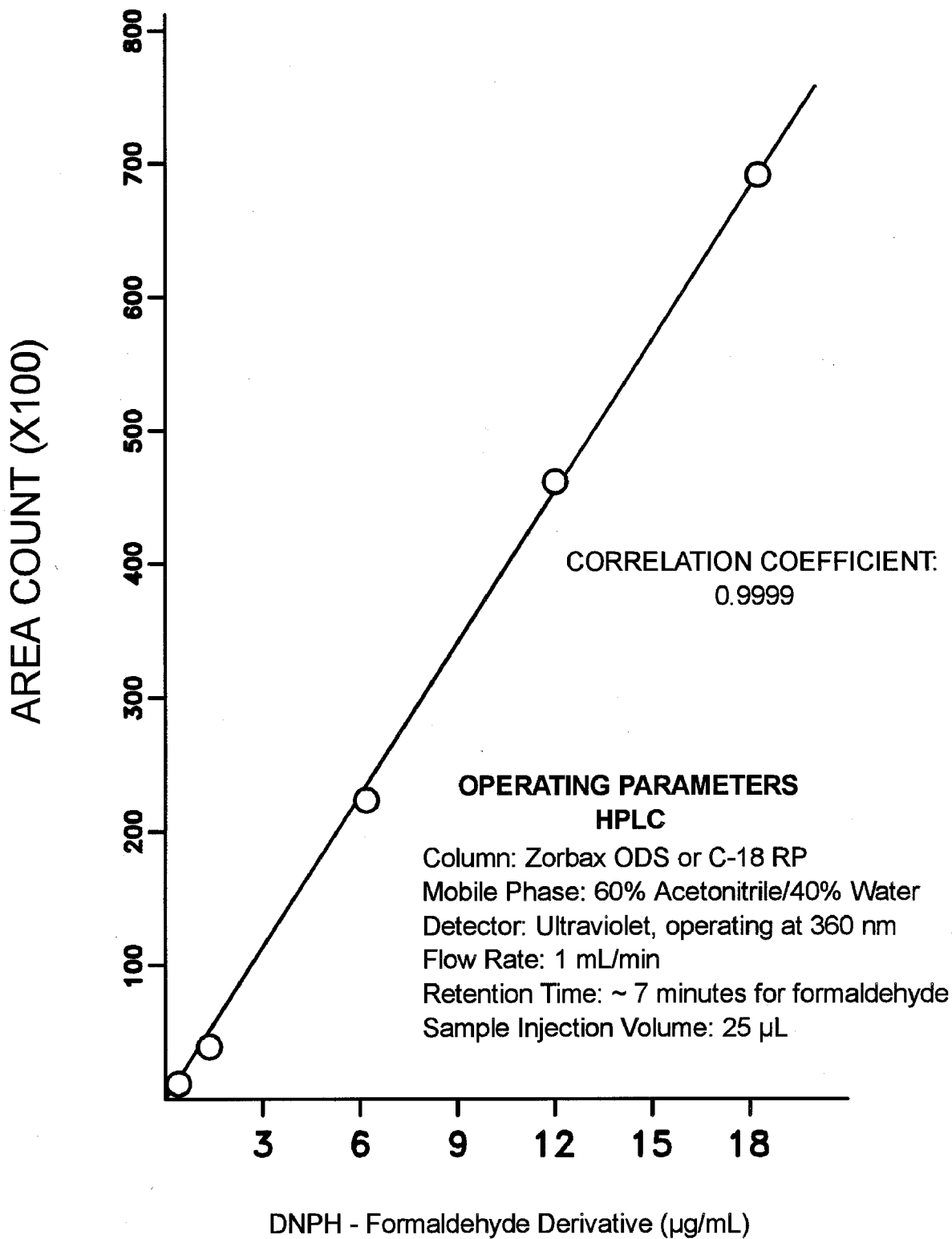

Figure 12. Example of calibration curve for formaldehyde.

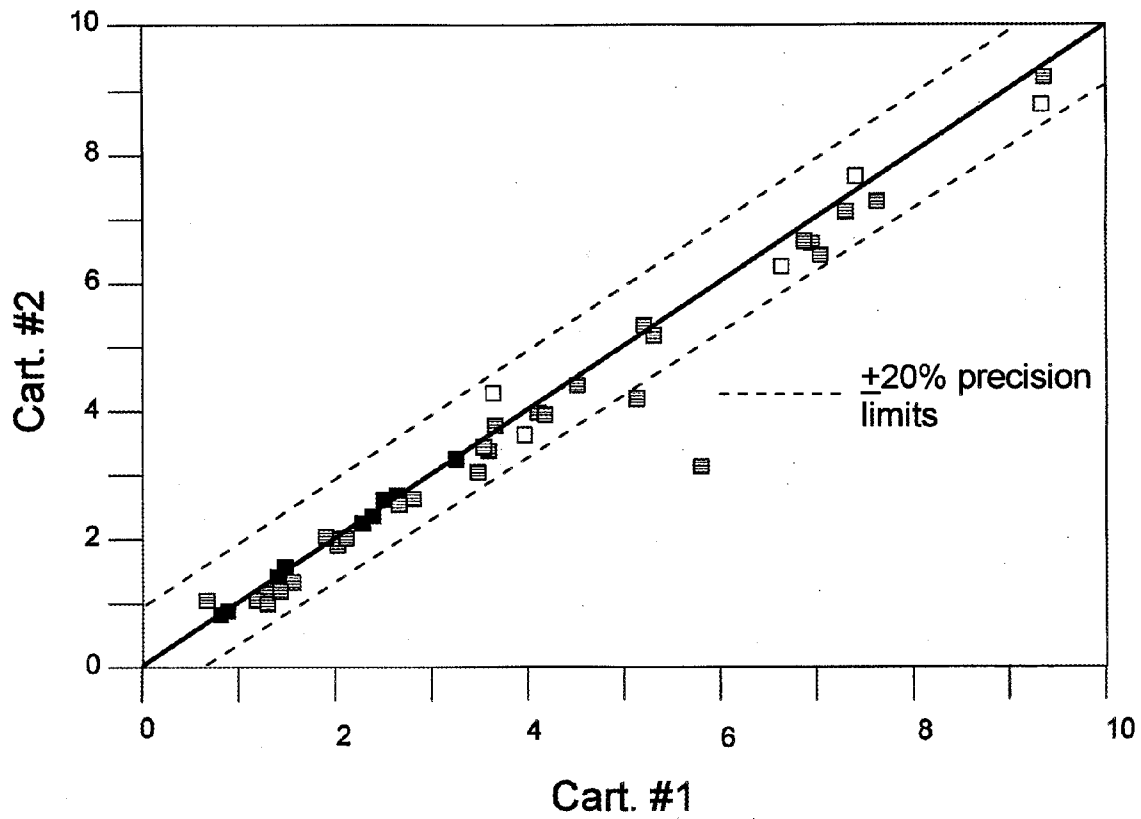

Figure 13. Historical data associated with collocated samples for formaldehyde (ppbv) in establishing 20% precision.

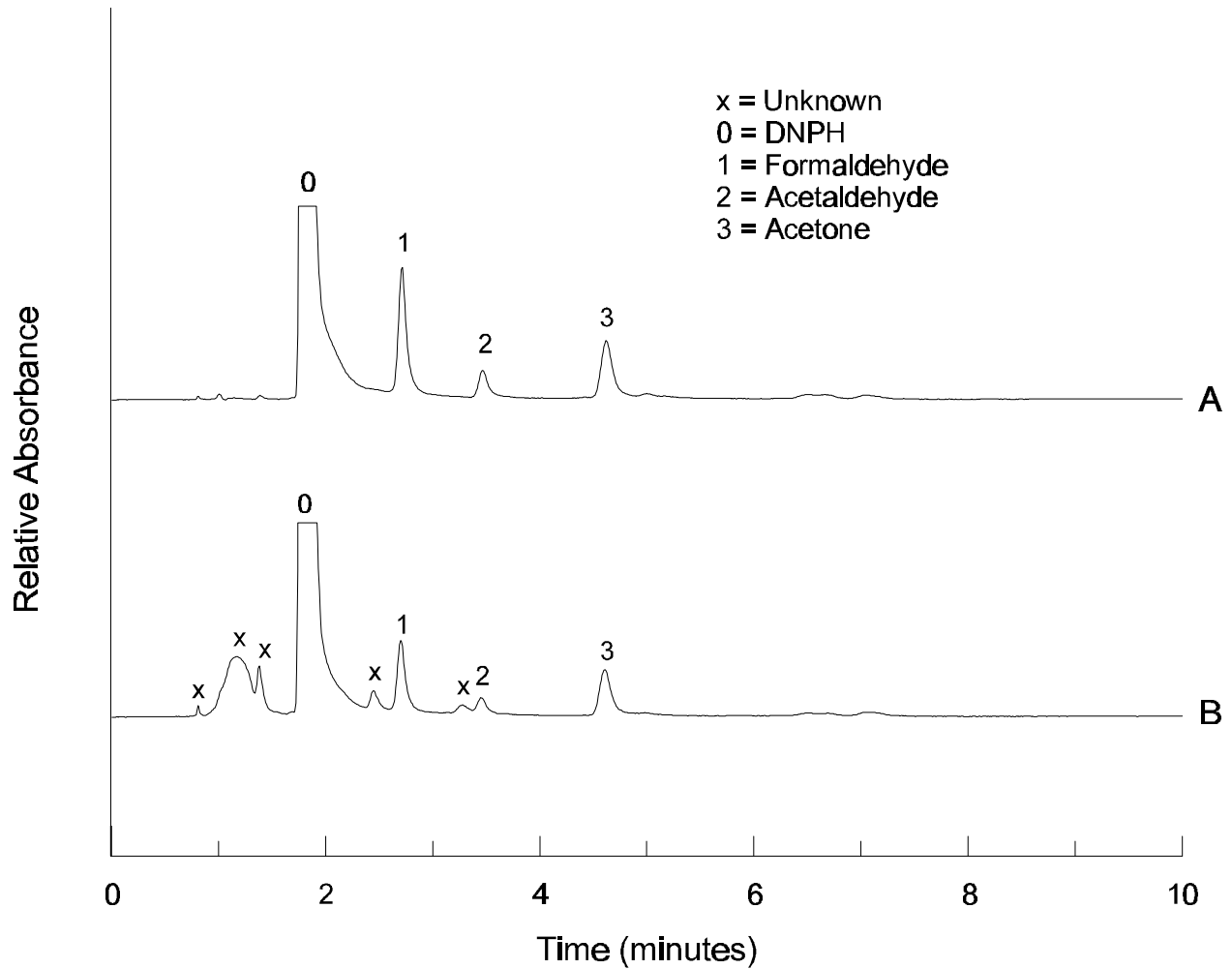

Figure 14. Example of analysis demonstrating DNPH-coated cartridges sampling air with (A) and without (B) ozone denuders, in the determination of formaldehyde.

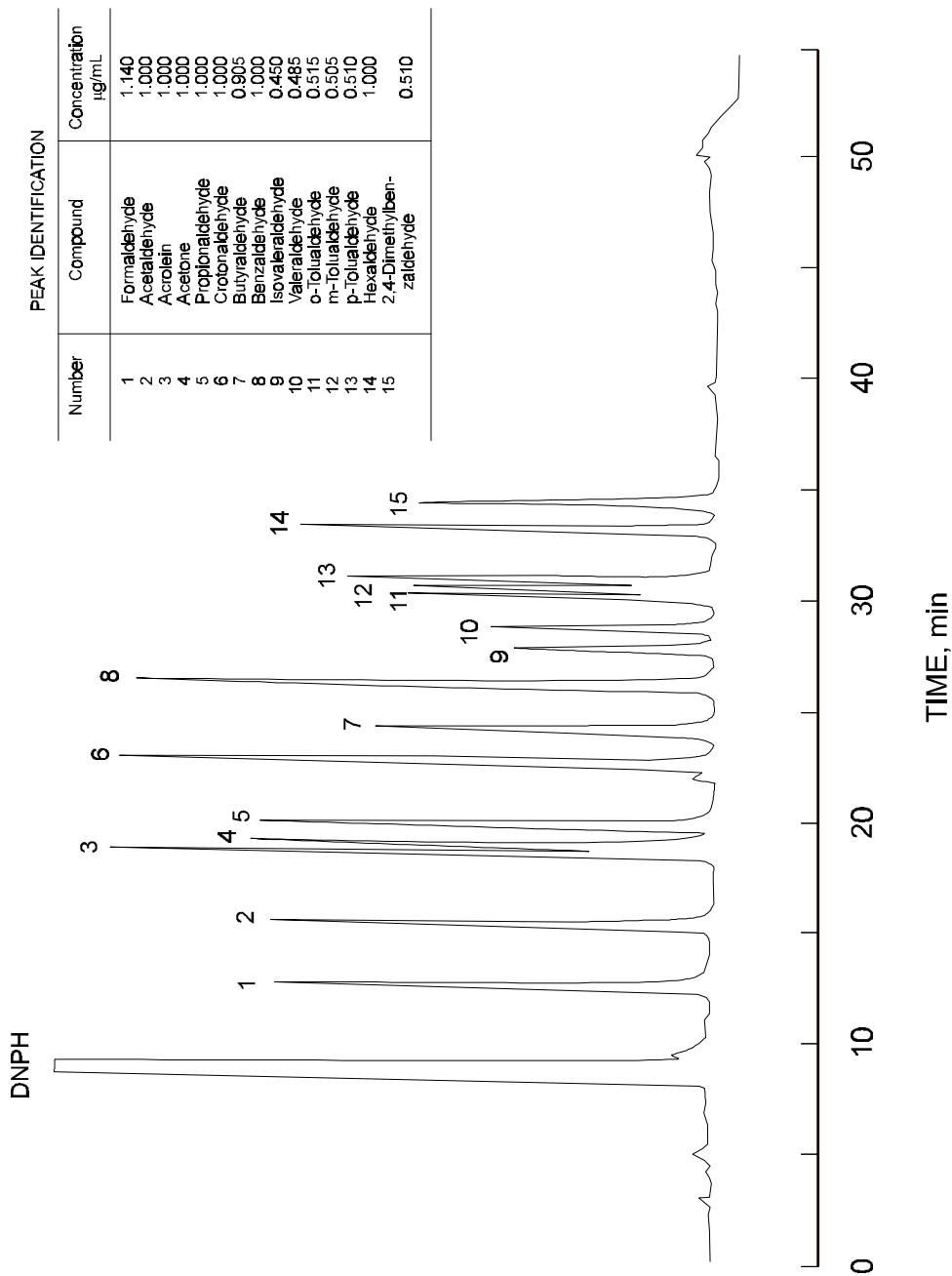

Figure 15. Typical chromatogram of a linear gradient program for analyzing other aldehydes/ketones from a DNPH-coated cartridge.